

INSTRUCTION MANUAL

2J1-9006-009 Ver.10 October, 2020



Double Beam Spectrophotometer

MODEL U-2910 UV-VIS SPECTROPHOTOMETER (MAINTENANCE)

This product is intended for research use only. It is not to be used for reporting patient diagnostic or therapeutic results.



- Before using the instrument, read the safety instructions and precautions carefully.
- Be sure to observe the safety instructions in this manual and the WARNING/CAUTION labels on the instrument.
- Keep this manual in a safe place nearby so it can be referred to whenever needed.

NOTICE:

1. The Information contained in this document is subject to change without notice for improvement.
2. This manual is copyrighted by Hitachi High-Tech Science Corporation with all rights reserved.
No part of this manual may be reproduced, transmitted or disclosed to a third party in any form or by any means without the express written permission of Hitachi High-Tech Science Corporation.
3. Hitachi High-Tech Science Corporation assumes no liability for any direct, indirect, or consequential damages arising from use not described in this manual.
Utmost care must be exercised when using the instrument.
4. This document does not provide any warranty or permission for industrial properties or any rights to grant license lawfully and without infringement.

© Hitachi High-Tech Science Corporation

1-17-1 Toranomom, Minato-ku, Tokyo, Japan

PREFACE

We thank you for purchasing the Hitachi Model U-2910 Double beam UV/VIS spectrophotometer.

This instrument is intended for photometric analysis and should not be used for other purposes.

Note that samples that may have been infected with bacteria or viruses are not applicable to this instrument.

This instrument is intended for use by persons having a basic knowledge of chemical analysis procedures.

Keep in mind that improper use of analytical instruments, chemicals or samples would result not only in wrong analytical data but also in consequences adverse to safety. Note that it is allowed only for persons having a basic knowledge of chemical analysis procedures to use this instrument.

Be sure to read this manual thoroughly before use to ensure correct use of the instrument.

Be sure to read instruction manual also to ensure correct use of the instrument.

ABOUT THIS MANUAL

This manual is prepared for users of Model U-2910 Double beam UV/VIS Spectrophotometer. This manual describes the operating instructions and maintenance/checkpoints.

At first read “IMPORTANT” (IMPORTANT –1 to 8) and “SAFETY SUMMARY” (SAFETY –1 to 12).

Also read Instruction manual of UV/VIS spectrophotometer (both operation manual and maintenance manual).

The cautionary instructions concerning safety are also contained in the maintenance edition of the instruction manual. Be sure to read them before attempting use.

If installation of this accessory is not finished read chapter one.

Contents of “IMPORTANT” and “SAFETY SUMMARY” is applied to parts supplied with this accessory.

IMPORTANT

Information for Users on WEEE (only for EU Countries)



This symbol is in compliance with the Waste Electrical and Electronic Equipment directive 2012/19/EU (WEEE). This symbol on the product indicates the requirement NOT to dispose of the equipment as unsorted municipal waste, but use the return and collection systems available.

Information on Disposal for Users

1. In the European Union

If you need to discard this product or discard user serviceable parts:
Please contact your local sales representative or distributor who will inform you of the recycle of the product.
You might be charged for the costs arising from take-back and recycling.

2. In other Countries outside the EU

If you wish to discard this product, please contact your local authorities and ask for the correct method of disposal.

Instruction Manual for U-2910

Cautions

The following is a statement of notice about EMC for Korea.

A 급 기기 (업무용 방송통신기자재)

이 기기는 업무용 (A 급) 전자파적합기기로서 판매자 또는 사용자는 이 점을 주의하시기 바라며,
가정외의 지역에서 사용하는 것을 목적으로 합니다. (O)

Warranty on Product

This product, inclusive of its accessories, is warranted to be free from defects in material or workmanship under normal use within the product specifications indicated in this manual and under conditions given below.

This warranty is void if the instrument is not used according to the instruction manual.

(1) Scope of Warranty

Any parts that prove to be defective in design or workmanship during the warranty period will be repaired, adjusted or replaced without charge. A substitute part may be used for repair, or replacement with an equivalent product may be made instead of repair. Such system components as a personal computer and printer to be updated frequently for improvement may not be available in original versions at the time of replacement.

The manufacturer assumes no liability for any damage to data or application software due to any possible fault or failure of this instrument.

(2) Warranty Period

One year from the date of initial installation

(In case a separate warranty document has been issued, the warranty period indicated in it takes precedence over the above period)

Consumables such as WI and D₂ lamps are excluded from warranty.

(3) Limitations and Exclusions on Warranty

Note that the following cases are excluded from the scope of this warranty, i.e., these cases are beyond the coverage of free-of-charge repair even during the warranty period indicated above.

- (a) Failure due to operation at a place not meeting the installation requirements specified by the manufacturer.
- (b) Failure due to power supply voltage/frequency other than specified by the manufacturer or due to abnormality in power supply.
- (c) Corrosion or deterioration of the piping due to impurities contained in gas, compressed air or cooling water supplied by the user.
- (d) Corrosion of the electric circuits or deterioration of the optical elements due to highly corrosive atmospheric gas.
- (e) Failure due to use of software, hardware or spare parts not supplied by the manufacturer.
- (f) Failure due to use not described in the manual or improper repair not approved by the manufacturer.
- (g) Failure due to maintenance or repair by other than service personnel qualified by the manufacturer.
- (h) Failure due to relocation or transport conducted not under the supervision of the manufacturer after the initial installation of the instrument.
- (i) Failure due to disassembly, modification or relocation not approved by the manufacturer.
- (j) Failure due to acts of God, including fire, earthquake, storm, flood, lightning, social disturbance, riot, crime, insurrection, terrorism, war (declared or undeclared), radioactive pollution, contamination with harmful substances, etc.

- (k) Failure of the hardware, or damage to the system software, application software or data due to computer virus infection.
 - (l) After disposal of this instrument, after its resale without prior approval from the manufacturer, consumable parts, and failure of any part that have reached the end of its service life.
 - (m) Failure due to a life-limited part that has exceeded the end of its useful lifetime.
- (4) Disclaimer of Warranty

THE MANUFACTURER MAKES NO WARRANTIES, EITHER EXPRESS OR IMPLIED, EXCEPT AS PROVIDED HEREIN, INCLUDING WITHOUT LIMITATION THEREOF, WARRANTIES AS TO MARKETABILITY, MERCHANTABILITY, FOR A PARTICULAR PURPOSE OR USE, OR AGAINST INFRINGEMENT OF ANY PATENT. IN NO EVENT SHALL THE MANUFACTURER BE LIABLE FOR ANY DIRECT, INCIDENTAL OR CONSEQUENTIAL DAMAGES OF ANY NATURE, OR LOSSES OR EXPENSES RESULTING FROM ANY DEFECTIVE PRODUCT OR THE USE OF ANY PRODUCT.

NO ORAL OR WRITTEN INFORMATION OR ADVICE GIVEN BY THE MANUFACTURER, ITS DEALERS, DISTRIBUTORS, AGENTS OR EMPLOYEES SHALL CREATE A WARRANTY OR IN ANY WAY INCREASE THE SCOPE OF THIS WARRANTY.

Service Life of This Instrument

This instrument has a useful service life of seven years after the date of its initial use (installation), which is estimated under the condition that periodic maintenance, checkup, replacement of life-limited parts, and repair of worn parts are carried out as specified in the present instruction manual.

(In use of the instrument under standard operating conditions
(8 h/day, 20 days/month))

For using the instrument beyond the useful service life, it shall be checked for safety by Hitachi High-Tech Science Corporation sales representative or service office of Hitachi High-Tech Science Corporation sales representative. (This safety check will be available on a chargeable basis.)

If use of the instrument is continued without receiving the safety check, the instrument might become faulty and cause a danger. Note that replacement may be recommended as a result of the safety check.

Installation, Relocation and After-sale Technical Service

(1) Installation and Relocation

- (a) Installation at delivery shall not be carried out by the user. It shall be carried out by our sales representative or the engineers who have been trained and qualified for this purpose by us in order to use the instrument safely and accurately.
- (b) Before installation, the user shall make preparations for satisfying the installation requirements in accordance with this instruction manual.
- (c) If relocation becomes necessary after initial installation (delivery), please contact the dealer from whom you purchased the instrument or our sales representative.

(2) After-sales Service

- (a) For after-sales service, contact our sales representative or service office of our sales representative.

- (b) For service after the warranty period, consult our sales representative or service office of our sales representative with regard to a maintenance and inspection service contract. (Service will be available on a chargeable basis.)
- (c) The maintenance and consumables of the instrument can be supplied within the useful service life of the instrument (7 years). Even after the period of useful service life, the parts and units can be supplied (within 10 years after the date of initial use) so far as they are obtainable. However, this measure will not lead to an extension of the 7-year useful service life which is assured by the manufacturer. And, if a part or unit is unavailable due to the discontinuance of its manufacture, a substitute part or unit may be supplied, for which we request your understanding.
- (d) It may be impossible to supply the main unit components other than the maintenance parts and consumables due to the discontinuance of main-unit manufacture, etc. If the instrument becomes faulty, it might be irreparable due to lack of such components. In this case, the user is requested to stop operation and replace the instrument with a new one.

Technical Seminars and Training Courses for Users

We offer technical seminars and training courses at either our or user's facilities to ensure proper and safe operation of the analytical instrument to its full performance. For further information, contact our sales representative. (Applicants will be charged.)

Other Precautions

Handling of Chemicals and Samples

- (1) The user is responsible for following relevant legal standards and regulations in handling, storage and disposal of chemicals and samples used in analytical operations with this instrument.
- (2) Reagents, standard solutions and accuracy-control samples shall be handled, stored and discarded as instructed by the respective suppliers.
- (3) Samples that may have been infected with bacteria or viruses are not applicable to this instrument.



SAFETY SUMMARY



Precautions on Safety

Before using the Model U-2910 Double beam UV/VIS spectrophotometer, be sure to read through and understand the safety instructions given below.

The hazard warnings that appear on the warning labels on the product or in the manual have one of the following alert headings consisting of an alert symbol  and signal word DANGER, WARNING or CAUTION.



: A safety alert symbol. Precedes every signal word for hazard warnings, and appears in safety related descriptions in the manual. Be sure to observe all the safety messages following this symbol. Failure to do so could result in serious injury or even death.



DANGER

: Indicates an imminently hazardous situation which, if not avoided, will result in death or serious injury.
(This warning does not apply to this product.)



WARNING

: Indicates a potentially hazardous situation which, if not avoided, can result in death or serious injury.
(This warning does not apply to this product.)



CAUTION

: Indicates a hazardous situation which, if not avoided, will or can result in minor or moderate injury, or serious damage of the product.

NOTICE

: Used to indicate an instruction for preventing damage to the instrument, damage to data, and/or environmental pollution and does not concern personal safety directly.

Other than the above, cautions for using Instrument correctly are shown in NOTE.

NOTE: Used to indicate an instruction for ensuring proper use of the product, so as to achieve accurate measurement and avoid any malfunction.



SAFETY SUMMARY



Common Safety Precautions

Cautions Prior to Use

- Read carefully the instruction manual and understand the contents before starting operation.
- Keep this instruction manual at hand so that you can read it anytime.
- Follow the procedures indicated in this manual for handling the product.
- Be sure to understand and observe all of the safety instructions in the manual.
- Make sure to observe all the hazard warnings attached to the instrument or provided in the manual. Failure to do so could result in personal injury and/or damage to the instrument.
- Be sure to follow all the methods of use instructed in the manual for operating the product.
- Do not modify the instrument, use non-specified parts, nor remove safety devices as it could be hazardous.
- Do not perform any operation or action other than described in this manual. When in doubt, please contact your nearest Hitachi High-Tech Science Corporation service office or representative.
- When using a chemical for analytical operation, be sure to provide proper ventilation in the laboratory room as per local requirements.
Inadequate ventilation could endanger your health.
- Keep in mind that the hazard warnings in the manuals or on the product cannot cover every possible case, as it is impossible to predict and evaluate all circumstances beforehand. Always be alert and use your common sense.



SAFETY SUMMARY



Common Safety Precautions (Continued)

Cautions In Use

If an abnormality such as unusual noise, odor, fuming or gas leakage occurs during operation of the instrument, immediately disconnect power to the instrument, and take proper safety measures as required. Then, notify your nearest Hitachi High-Tech Science Corporation sales representative or service office of Hitachi High-Tech Science Corporation sales representative.

Installation, Maintenance, and Relocation

- At the time of delivery, installation of the instrument shall be carried out by or under supervision of qualified service personnel of the manufacturer or its authorized service agent for ensuring safety and high accuracy in operation of the instrument. It is not permitted for the user to carry out installation.
- After completion of installation, check that all the standard parts are equipped. If the instrument is made active with any one of the standard parts not equipped, a failure could occur to result in a hazardous condition.
If any item is missing or damaged or if you have any question, notify the installation personnel at site or your nearest Hitachi High-Tech Science Corporation sales representative or service office of Hitachi High-Tech Science Corporation sales representative.
- The maintenance and checkup procedures to be taken by the user are only those described in the manual. When taking the maintenance and checkup procedures described in the manual, attain a clear understanding of them.
Do not perform other maintenance and checkup procedures to avoid jeopardizing safety and causing troubles in the instrument.



SAFETY SUMMARY



Common Safety Precautions (Continued)

Cautions on Installation, Maintenance, Relocation

- After installation, do not relocate the instrument. If the instrument is relocated, vibration or impact to be applied during relocation could cause a malfunction in the optical components that have been adjusted precisely.
- If any warning/caution label has become illegible due to deterioration with age or it has been damaged due to any cause, notify your nearest Hitachi High-Tech Science Corporation sales representative or service office of Hitachi High-Tech Science Corporation sales representative for replacement with a new one.
- The parts having a useful lifetime indicated in this manual must be replaced periodically as specified. If the instrument is operated though the replacement of life-limited parts has already been required, the instrument might become faulty due to part deterioration, etc., causing leak, fuming, combustion or the like trouble on safety.
For other than the replacement procedures instructed in this manual, contact your nearest Hitachi High-Tech Science Corporation sales representative or service office of Hitachi High-Tech Science Corporation sales representative.
- For reducing a risk of trouble occurrence due to physical deterioration, it is requested to carry out the safety check (available on a chargeable basis) or replacement with a new one when the instrument has reached the end of its useful service life.



SAFETY SUMMARY



Safety Instructions in This Manual

Shown below are the safety instructions contained in this manual and their relevant sections in it.



DANGER Indications

The indication”  DANGER” does not apply to this instrument.



WARNING Indications

Electric Shock upon touching Hazardous Voltage (500 V)

Touching the D₂ lamp power supply voltage (500 V) may cause an electric shock, resulting in fatal or serious injury.

Before replacing the D₂ lamp, make sure that the POWER switch of the spectrophotometer main unit is turned OFF.

(Chapter 5)

Electric Shock upon touching Hazardous Voltage

Touching the power supply voltage may cause an electric shock, resulting in fatal or serious injury. Before connecting the power cord, make sure that the POWER switch of the spectrophotometer main unit is turned OFF.

(Chapter 1)



SAFETY SUMMARY



CAUTION Indications

Fatigue due to Long Hours of Operation

Operation while watching the display in the same posture for long hours will cause fatigue to accumulate in the eyes and body. To avoid this, one should take a break for 10 to 15 minutes at every hour in order to rest the eyes and body.

Burns upon touching Hot Surface

The D₂ lamp and WI lamp are very hot. Touching the lamp can burn you. Turn off the POWER switch and allow the lamps to fully cool down before replacing or adjusting the lamp.

(Chapter 5)



SAFETY SUMMARY

NOTICE

Disposal of Waste Solution

Be sure to collect waste solution and treat it for proper disposal in accordance with the relevant laws and regulations regarding water pollution control and sewage treatment.

Improper treatment of waste solution may result in environmental pollution and could also lead to a penalty.

Accuracy and Precision of Measured Values

Carry out periodic inspection and check whether the system is operating normally. If necessary, conduct measurement on a control sample.

Data Backup

Data stored on the hard disk may become unusable due to a system failure, wrong operation, computer virus infection, etc. To ensure data integrity in case of accidental damage to the hard disk, **periodically make backup copies of hard disk files onto floppy disks.**

To prevent an erroneous operation on the hard disk, always reserve approx. 100 MB of free space as a working area for application software.



SAFETY SUMMARY

NOTICE (Continued)

Protection against Computer Viruses

If any program/data is damaged suddenly or an unexpected operation/screen is encountered, the personal computer is suspected of being infected by a computer virus.

Computer viruses are malicious programs that sneak into personal computers to cause misbehavior or damage to data. And, a program designed to offer protection against computer viruses is called a vaccine program.

Possible causes of virus infection are:

- Downloading a virus-laden program through communication.
- Using a floppy disk or other storage medium infected by a virus.

Note also that once any personal computer is infected by a virus, it may spread to other computers via communication or storage medium.

Never use a program or storage medium that is suspected of containing a virus.

If there is a possibility of virus infection, check for a virus using a vaccine program. Note, however, that some kinds of vaccine programs cannot eradicate particular viruses. **So, be sure to make a backup of hard disk files beforehand.**

The user is requested to prepare a vaccine program and carry out virus removal on his or her own responsibility.



SAFETY SUMMARY

NOTICE (Continued)

Power Interruption

On occurrence of momentary power voltage drop due to power interruption or lightning, the personal computer may become faulty or the system software, application software or data may be damaged. For protection against momentary power voltage drop, it is advisable to use an AC uninterruptible power supply unit (stated according to the Japanese Electronic Industry Development Association guidelines for protection against momentary power voltage drop in personal computers).

Turning On/Off Personal Computer

Do not turn off power to the personal computer while the hard disk or floppy disk drive is active. If power to the personal computer is turned off while the hard disk or floppy disk is being accessed, the personal computer may become faulty or data/software stored in it may be damaged.

Before turning off power to the personal computer, be sure to quit the fluorescence spectrophotometer control/data processing program (UV Solutions program) first and then take the shut-down procedure using the system software.



SAFETY SUMMARY

NOTICE (Continued)

Burst of a lithium battery

This spectrophotometer uses a lithium battery to backup the data in the memory. A lithium battery may burst should it be handled improperly. Be sure not to attempt to charge, disassemble, nor throw into the fire, under any circumstance. The battery should be handled with a strict separation from non-industrial wastes. When the lithium battery needs to be replaced (for example, when an error message RAM NG (RAM failure) appears frequently on the screen, it may be attributable to deterioration of the battery), contact our sales representative for this spectrophotometer or our service office nearest.

Entrust the battery replacement to the service person qualified through our technical training course therefor. (Battery replacement after expiration of the warranty period is a fee-charging service.) (This term is not mentioned in the text of this instruction manual.)

Caution in Moving Instrument

This spectrophotometer is a heavy article, which weighs about 29 kg. In moving the instrument, engage two persons for safe handling. Hold the instrument firmly at both sides thereof, then move very carefully to prevent injury due to accidental dropping.

(Chapter 1)

Prevention of Falling or Toppling

This spectrophotometer may accidentally fall to injure. Secure each unit of the spectrophotometer on installation.

(Chapter 1)



SAFETY SUMMARY



Warning Labels

The warning labels shown below are attached on the Model U-2910 Double beam UV/VIS spectrophotometer. Read the warning labels carefully, and check the instructions on them to attain a clear understanding with reference to actual parts. Periodically check the appearances of these warning labels to see if they are clean to allow easy reading over a safe distance. If any one of the warning labels becomes illegible due to deterioration, contact your local Hitachi High-Tech Science Corporation sales representative or service office of Hitachi High-Tech Science Corporation sales representative for replacement with a new one.

- (1) Electric Shock due to Contact with Inside of Instrument

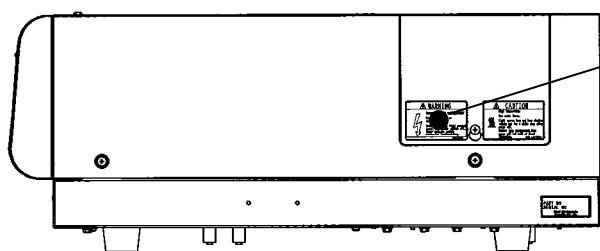

Light source compartment



- (2) Electric Shock due to Contact with Power Supply

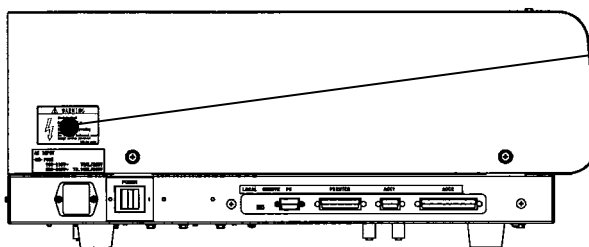

Side of spectrophotometer main unit

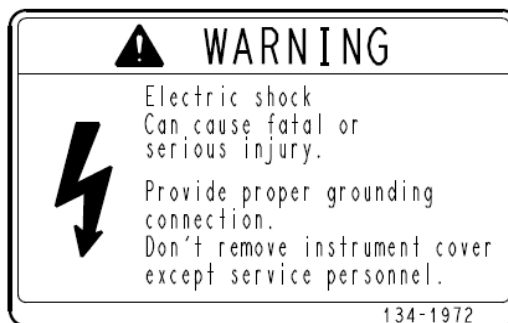



SAFETY SUMMARY



Caution Label



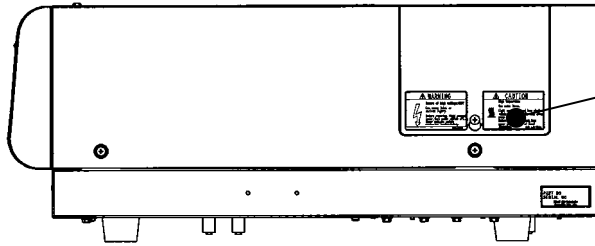



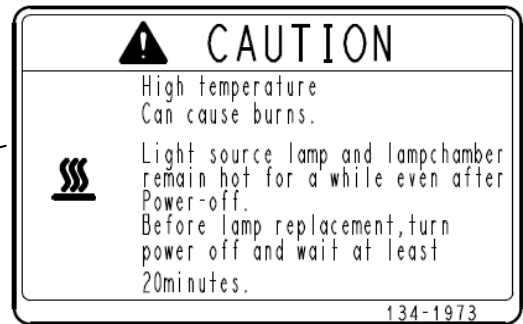

(1) Burns due to Contact with Hot Part



Light source compartment



CONTENTS

PREFACE	PREFACE - 1
ABOUT THIS MANUAL	PREFACE - 1
IMPORTANT	IMPORTANT - 1
Information for Users on WEEE (only for EU Countries)	IMPORTANT - 1
Warranty on Product	IMPORTANT - 2
Service Life of This Instrument	IMPORTANT - 5
Installation, Relocation and After-sale Technical Service	IMPORTANT - 5
Technical Seminars and Training Courses for Users	IMPORTANT - 6
Other Precautions	IMPORTANT - 7
 SAFETY SUMMARY	
 Precautions on Safety	SAFETY - 1
 Common Safety Precautions	SAFETY - 2
Cautions Prior to Use	SAFETY - 2
Cautions In Use.....	SAFETY - 3
Installation, Maintenance, and Relocation	SAFETY - 3
Cautions on Installation, Maintenance, Relocation	SAFETY - 4
 Safety Instructions in This Manual	SAFETY - 5
 DANGER Indications	SAFETY - 5
 WARNING Indications	SAFETY - 5
 CAUTION Indications	SAFETY - 6
NOTICE	SAFETY - 7
 Warning Labels	SAFETY -11
 Caution Label	SAFETY -12
1 INSTALLATION	1 - 1
1.1 UNPACKING (INFORMATION TO CUSTOMER)	1 - 1
1.2 INSTALLATION CONDITIONS	1 - 2
1.2.1 Power Requirements	1 - 2
1.2.2 Installation Place	1 - 2
1.3 INSTALLATION ENVIRONMENT	1 - 2
1.3.1 Operating Temperature Range	1 - 2
1.3.2 Operating Humidity Range	1 - 2
1.3.3 Storage Temperature Range	1 - 2
1.3.4 Atmosphere, Gas	1 - 3
1.3.5 Other General Conditions	1 - 3
1.4 CHECK OF DELIVERED CONTENTS	1 - 4
1.5 ASSEMBLY	1 - 4
1.6 ANTI-EARTHQUAKE MEASURE	1 - 5
1.7 CHECK OF POWER VOLTAGE AND FUSE	1 - 6

1.8	CABLE CONNECTION	1 - 7
1.9	CONNECTION OF POWER CORD AND GROUNDING WIRE	1 - 8
1.10	INSPECTION AFTER INSTALLATION/ASSEMBLY ...	1 - 9
1.11	POWER-ON	1 - 9
1.12	INSTALLATION OF UV-SOLUTIONS PROGRAM	1 - 9
1.13	TERMINATING OPERATION	1 - 10
2.	FUNCTION	2 - 1
2.1	OUTLINE	2 - 1
2.2	INSTRUMENT APPEARANCE	2 - 1
2.2.1	Sample Compartment	2 - 2
2.2.2	Left Side Panel of Spectrophotometer	2 - 2
2.2.3	Front of Spectrophotometer	2 - 3
2.3	PRINCIPLE OF OPERATION	2 - 4
2.3.1	OPTICAL SYSTEM	2 - 4
2.3.2	Signal Processing and Control System	2 - 5
2.4	MEASURING FUNCTIONS	2 - 6
2.4.1	Measuring Mode	2 - 6
2.4.2	Quantitative Calculation	2 - 6
2.4.3	Wavelength Scan	2 - 7
2.4.4	Time Scan	2 - 7
2.4.5	Secondary Processing of Data	2 - 7
2.4.6	Baseline Correction	2 - 8
2.4.7	Auto Calibration and Self-Diagnosis Functions	2 - 8
2.5	SPECIFICATIONS	2 - 9
3.	CALIBRATION OF INSTRUMENT	3 - 1
3.1	INTRODUCTION	3 - 1
3.2	0%T MEASUREMENT	3 - 2
3.3	WAVELENGTH CALIBRATION	3 - 2
3.4	SYSTEM BASELINE MEASUREMENT	3 - 2
4.	MAINTENANCE	4 - 1
4.1	MAINTENANCE AND CHECKUP	4 - 1
4.1.1	Purpose of Maintenance	4 - 1
4.1.2	Cleaning Sample Compartment.....	4 - 1
4.1.3	Cleaning Spectrophotometer Cover	4 - 2
4.1.4	Cleaning and Storage of Cell.....	4 - 3
4.1.5	Lubrication	4 - 3
4.1.6	Cleaning Transmission Window Plate of Sample Compartment	4 - 3
4.2	PERFORMANCE CHECK	4 - 4
4.2.1	Wavelength Accuracy	4 - 5
4.2.2	Wavelength Setting Repeatability	4 - 7
4.2.3	Bandpass	4 - 9
4.2.4	Noise Level	4 - 10
4.2.5	Baseline Stability	4 - 12

4.2.6	Baseline Flatness	4 - 14
4.3	TROUBLESHOOTING	4 - 16
5.	REPLACEMENT OF PARTS	5 - 1
5.1	INTRODUCTION	5 - 1
5.2	CONSUMABLE PARTS	5 - 1
5.3	REPLACEMENT OF LIGHT SOURCE LAMP	5 - 2
5.3.1	Light Source Lamp Replacement Procedure	5 - 2
5.3.2	Lamp Turn-On Time Resetting	5 - 5
5.3.3	Lamp Adjustment	5 - 6
5.4	STORAGE	5 - 9
5.4.1	After Measurement	5 - 9
5.4.2	When Instrument will not be used for Long Time	5 - 9
APPENDIX 1. ABSORPTION		
	SPECTROPHOTOMETRY	APPENDEX -1
APPENDIX 2. FOR PROPER USE OF		
	SPECTROPHOTOMETER	APPENDEX -2
INDEX		
		INDEX -1

1. INSTALLATION

1.1 UNPACKING (INFORMATION TO CUSTOMER)

Unpack the shipping crate, carefully take out the spectrophotometer and place it on a table.

CAUTION

CAUTION on handling a heavy article

U-2910 weighs about 29 kg. In moving the instrument, engage two persons for safe handling. Hold the instrument firmly at both sides thereof, and then move very carefully to prevent injury due to accidental dropping.

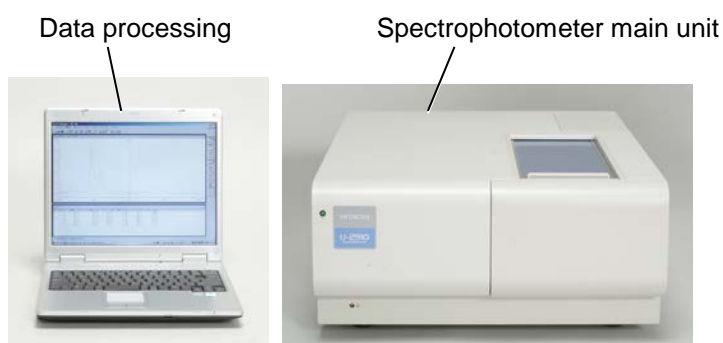
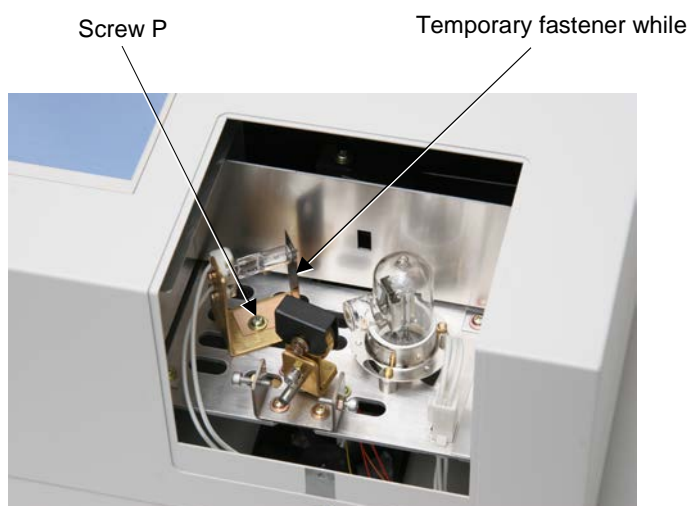

Fig. 1-1 Model U-2910 Spectrophotometer

- NOTICE 1:** The light source switching mirror is temporarily protected with a sponge packing for safe transportation. Prior to use, remove the packing opening the light source cover.
- 2:** Wl lamp is temporarily secured with a temporary fastener while transportation. Remove the fastener before use.



1.2 Installation Conditions

1.2 INSTALLATION CONDITIONS

Check that the following conditions are satisfied for the installation of the spectrophotometer.

1.2.1 Power Requirements

- Power supply : AC 100, 115, 220, 230 or 240 V
voltage Fluctuation should be within $\pm 10\%$ of rated voltage.
- Frequency : 50 or 60 Hz
 Fluctuation should be within $\pm 0.5\text{Hz}$ of rated frequency.
- Power source : 300 VA or more
capacity It is recommended to provide a capacity of 500 VA or more in consideration of joint use of associated accessory devices.
- Grounding line : Grounding resistance should be 100 Ω or less.

1.2.2 Installation Place

- Floor area : Width of 500 mm and depth of 605 mm or more. Give space at least 200 mm on both sides of the main unit.
- Work table strength : Flat-top table capable of withstanding weight of 29 kg or more.

1.3 INSTALLATION ENVIRONMENT

1.3.1 Operating Temperature Range

5 to 35 °C

In order to perform measurement under the most stable condition, we recommend that the instrument be used in an air-conditioned room at 20 to 25 °C.

1.3.2 Operating Humidity Range

45 to 85%

1.3.3 Storage Temperature Range

-20 to +60 °C

1.3.4 Atmosphere, Gas

- (1) Atmosphere should be free of acidic or alkaline gas or other gases that may corrode metal.
- (2) Atmosphere should also be free of vapor from organic solvents (such as benzene and thinner) that may dissolve paint.

1.3.5 Other General Conditions

- (1) Avoid direct sunlight (otherwise optical performance might deteriorate or the housing might be discolored). Install the instrument as far away from a window as possible.
- (2) A strong vibration or shock that can be felt by the human body must not be transmitted to the instrument (otherwise the fine adjustment mechanism might malfunction).
- (3) Avoid the vicinity of a heat generating apparatus such as a gas burner, electric heater, or oven in order to prevent the instrument cover being heated (beyond 60 °C).
- (4) Avoid the vicinity of instruments that generate a strong electric field (such as an electric welding machine, high frequency furnace, or pole transformer).
- (5) Avoid a dusty environment (otherwise optical performance might become out of order).
- (6) The instrument should be free from an abrupt variation of power supply voltage (which constitutes a noise source).
- (7) Do not frequently turn on and off electric instruments (such as stirrer or vibrator) that are not provided with a noise-preventive device and are connected on the same power line as the spectrophotometer.

NOTICE : The optical system is very delicate. The control unit incorporates high-density electronic circuit components that function as a computer. The above-stated cautions and conditions should therefore be strictly observed.

1.4 Check of Delivered Contents

1.4 CHECK OF DELIVERED CONTENTS

After unpacking, check the contents of delivery against the packing list. If any part is missing or damaged, or if you have any question, contact your nearest Hitachi High-Tech Science Corporation sales representative.

1.5 ASSEMBLY



WARNING

Contact with the power supply voltage may cause an electric shock, resulting in fatal or serious injury. Do not connect the power cord to the outlet until the assembly work is completed.

The light source switching lever in the light source compartment is held in place by sponge material to prevent its moving during transport. Remove the sponge material in the following procedure.

- (1) Remove the light source cover to open.
- (2) Take out the sponge material and temporarily fastener while transportation.
- (3) Replace the light source cover to close.

1.6 ANTI-EARTHQUAKE MEASURE

Two threaded screw holes for a clamp are provided on both the right and left sides of the body to secure the spectrophotometer with an anti-earthquake measure.

Use these threaded screw holes to secure the photometer as needed. (Each of the threaded screw holes is for a 4 mm screw, and the spacing of two holes is 50 mm.) (The user needs to prepare clamps and screws.)

Part No. 2J1-1365, Fastening Plate

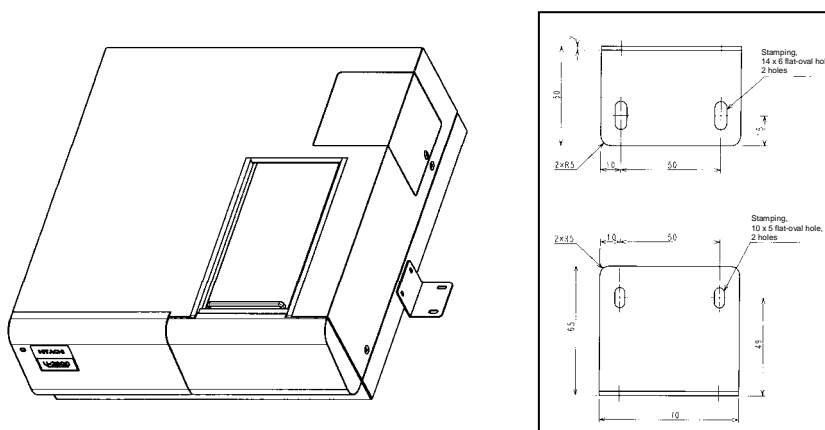

Drawing of the clamp used in Fig.1-2

Fig. 1-2. Example of securing spectrophotometer

Secure the personal computer on the laboratory table with retaining bands as needed.



Fig. 1-3. Example of securing personal computer

1.7 Check of Power Voltage and Fuse

1.7 CHECK OF POWER VOLTAGE AND FUSE



WARNING

Contact with the power supply voltage may cause an electric shock, resulting in fatal or serious injury. Before checking the voltage and fuse, make sure the power cord is disconnected.

First check if the line voltage to be used matches the allowable line voltage indicated on the label beside the power connector on the spectrophotometer.



Fuse holder

Fig. 1-2 Power Connector

Check if the fuse capacity is suitable for the line voltage to be used.

Table 1-1

Voltage	Fuse Capacity	Part No.
115 V	5 A (time lag type)	J821399
220 V/230 V/240 V	3.15 A (time lag type)	J821397

1.8 CABLE CONNECTION

Connect cables as indicated in Fig. 1-5.

 WARNING
Contact with the power supply voltage may cause an electric shock, resulting in fatal or serious injury. Make sure the power switch is OFF before the cable connection, and connect the power cord last.

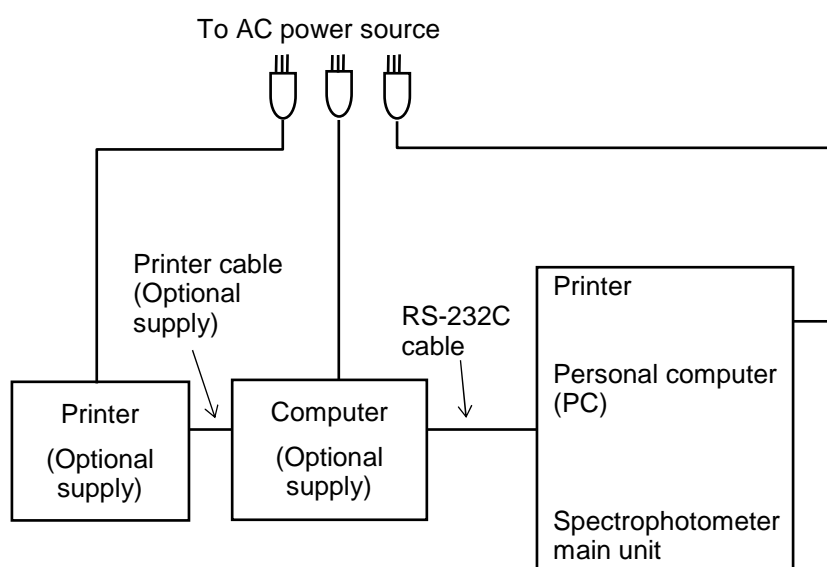

Fig. 1-4 Cable Connection

1.9 Connection of Power Cord and Grounding Wire

1.9 CONNECTION OF POWER CORD AND GROUNDING WIRE

- (1) Plug the power cord securely into the connector of the main unit.
- (2) When using a plug adapter or an extension cord, make sure its grounding wire is connected securely to the grounding terminal.

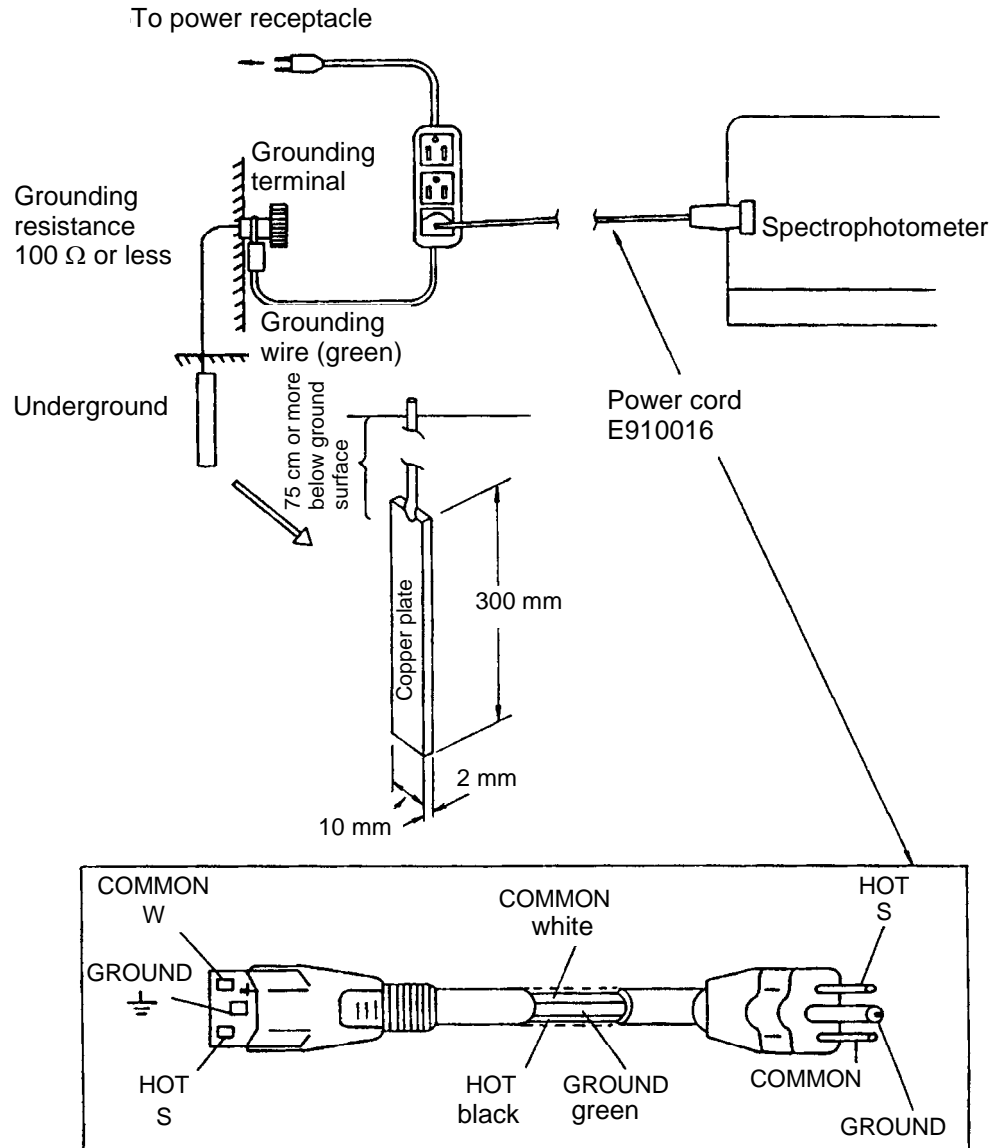

Fig. 1-6 Grounding

1.10 INSPECTION AFTER INSTALLATION/ASSEMBLY

The installation and assembly of the instrument are thus completed. Make a check again on the following items.

- (1) Is there any abnormality at the place of installation?
- (2) Has the sponge packing used for holding the light source switching lever during transport been removed?
- (3) Has the power voltage been set correctly?
- (4) Is the power cord connected correctly?
Is the grounding wire grounded according to the specification?
- (5) Is the cord connected correctly between spectrophotometer main unit and the computer?
- (6) Is the printer installed and connected correctly?
- (7) Is there any object that cuts off the light beam in the sample compartment of the spectrophotometer?
Make sure there are no other abnormalities, and close the lid of the sample compartment in place.

1.11 POWER-ON

Plug the power cord adapter into a power receptacle and then turn ON the power switch of the spectrophotometer.

1.12 INSTALLATION OF UV-SOLUTIONS PROGRAM

Refer to Chapter 1 in the operation section of the instruction manual.

1.13 Terminating Operation

1.13 TERMINATING OPERATION

On the end of the measuring, terminate the instrument according to the procedure given below.

- (1) Choose the termination or quitting command from the file menu.



Fig. 1-7

Choose [Yes] to end UV Solution program.

- (2) Turn OFF the power switch on the spectrophotometer main unit.
- (3) Click [Start] button on Windows XP. Choose closing Windows, choose "Bring computer ready to be switched off.", and then choose [Yes].
- (4) Turn off the personal computer and its monitor.
- (5) Turn off the printer.

2. FUNCTION

2.1 OUTLINE

The U-2910 spectrophotometer is an instrument for photometric analysis in the ultraviolet and visible regions. Described below are the functions of the instrument.

NOTICE: Model U-2910 spectrophotometer shares parts with Model U-2900 spectrophotometer. Some switches or connectors on the instrument will not function.

2.2 INSTRUMENT APPEARANCE

This instrument is comprised of the spectrophotometer main unit and the control/data-processing unit.

Fig. 2-1 shows the appearance of this instrument.

In an optional supply, a printer is available as a data output unit.

Control/data-processing unit
(Optional supply)

Spectrophotometer
main unit



Fig. 2-1 Model U-2910 Spectrophotometer

2.2 Instrument Appearance

2.2.1 Sample Compartment



Fig. 2-2 Sample Compartment

2.2.2 Left Side Panel of Spectrophotometer

The left side panel of the spectrophotometer has the switch and connectors shown below.



- (1) Local-Remote selector switch (Does not function)
(2) RS-232C communication port
(3) Printer output connector
(4) Accessory 1 connector
(5) Accessory 2 connector
(6) External memory connector (Does not function)

Fig. 2-3 Left Side Panel of Spectrophotometer

- (1) In Model U-2910, a computer controls this switching; the Local-Remote selector switch does not function (Selecting "Local" or "Remote" does not affect the instrument operation.)
- (2) Connection to RS-232C communication cable when UV Solutions control program is to be used. This connection is an exclusive use for UV Solutions control program.
- (3) For connecting a printer cable; does not function in Model U-2910 as a computer controls the instrument. Connect the printer cable to the printer port on the computer.
- (4) For connecting a cable for AS-1010.
- (5) For connecting a connector from an accessory such as Auto Sipper 6-cell Positioner.
- (6) In Model U-2910, a computer controls storing data; this External memory connector does not function. The external memory connects to USB port on the computer

2.2.3 Front of Spectrophotometer

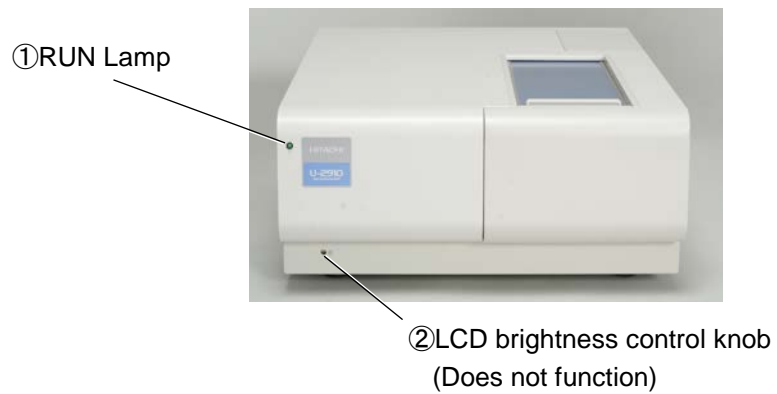

Fig. 2-4 Front of Spectrophotometer

- (1) This lamp, when lights, indicates sound work of the computer built in the spectrophotometer main unit. When the working order of the instrument is sound, the lamp begins to light several seconds after turning on the power switch, and continues to light until the power switch is turned off. The lamp being not-lighting or flickering represents something being wrong with the computer. Turn off the power switch once and on again. If such unstable lighting state repeats or still continues, take action for remedy according to the instructions described in “4.4 Trouble Shooting”
- (2) In Model U-2910, this knob does not function; the instrument is not provided with an LCD.

2.3 Principle of Operation

2.3 PRINCIPLE OF OPERATION

2.3.1 Optical System

Fig. 2-5 shows the optical system of Model U-2910. The white light emitted from the light source is led to the monochromator of Seya-Namioka mount that utilizes a concave diffraction grating (with grating constant of $1/600$ mm, blaze wavelength of 250 nm, and diffraction area of $20 \text{ mm} \times 25 \text{ mm}$), where it is transformed into a monochromatic beam. The beam from the monochromator then passes through a filter, toroidal mirror (M2), and is separated into sample beam and reference beam by half mirror (HM). The sample beam that has passed through the sample in the sample compartment enters a detector, where it is converted into electric signal. The reference beam also passes through the sample and enters a detector in the same way, and this signal is used as a reference in photometry.

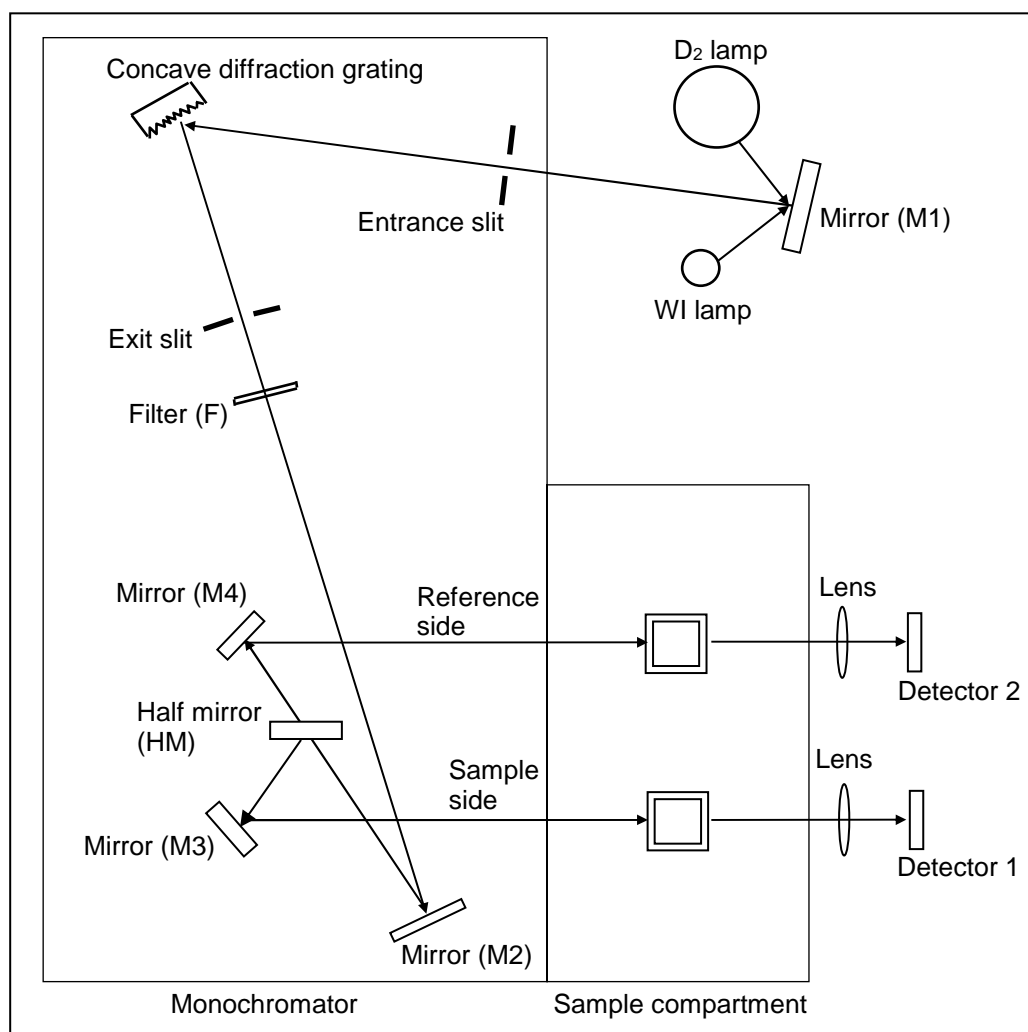

Fig. 2-5 Optical System of Model U-2910 Spectrophotometer

2.3.2 Signal Processing and Control System

Figure 2-6 shows the signal processing and control system. This system can be controlled either from keyboard or by an external personal computer. The optical signal converted to an electric signal by the detector is amplified and undergoes A/D conversion, after which it is log-converted by the software and becomes absorbance data. The result of measurement appears on the LCD and is printed out from the printer.

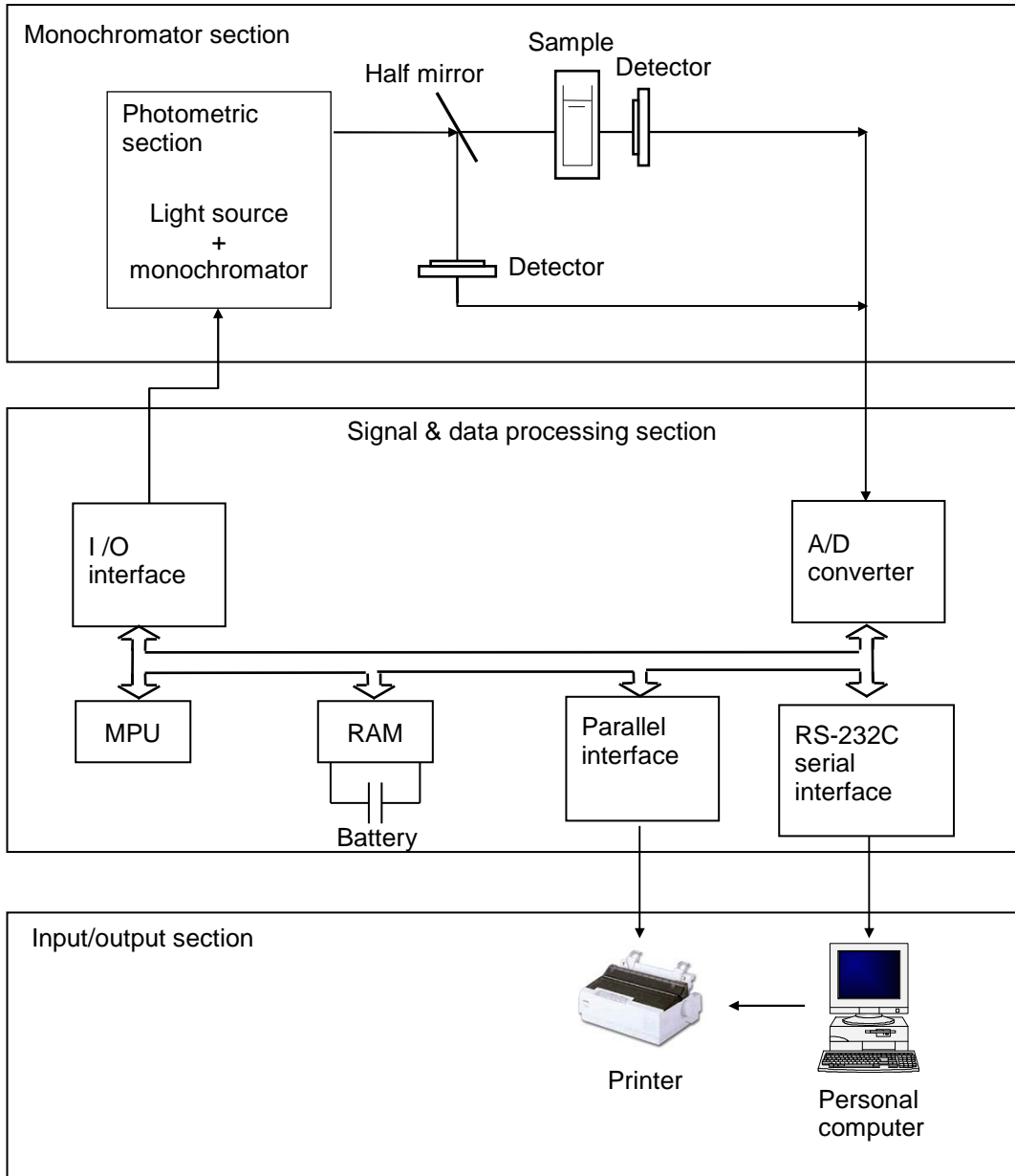

Fig. 2-6 Signal Processing and Control System

2.4 Measuring Functions

2.4 MEASURING FUNCTIONS

2.4.1 Measuring Mode

UV Solutions program offers measuring modes as listed below:

- Quantitative calculation
- Wavelength scan
- Time scan

2.4.2 Quantitative Calculation

This spectrophotometer has a function for calculating sample concentration upon creating a calibration curve. Following are the features of this function.

(1) Creation of Calibration Curve

- (a) A maximum of 20 standards can be measured, and the acquired values are connected to each other with segmented lines or regression lines determined by the least squares method for generating a calibration curve. It is also possible to measure each standard up to 5 times and then obtain the average values for generating a calibration curve.
- (b) The calibration curve can be regenerated upon re-measuring specific standards.
- (c) The calibration curve can be graphically displayed on the LCD, and the value at each point can be read out by moving the cursor to each point.
- (d) The calibration curve can be graphically plotted with the printer.
- (e) The calibration curve can also be generated upon entering factor values.
- (f) Measurement results and the calibration curve are displayed jointly on one screen, which permits measuring on observing the calibration curve.
- (g) The fitness of standard values and calibration curve can be judged by using automatically calculated determining factors.
- (h) The calibration curve can be generated by means of 2 or 3-wavelength calculation.

(2) Statistical calculation

Calculation of mean value and standard deviation (SD) are available.

(3) Determination of upper and lower limit

The instrument determines upper and lower limits of data.

2.4.3 Wavelength Scan

(1) The scan speed is available for setting at speeds of 10 to 3600 nm/min.

(2) Photometric values can be printed out at a specified wavelength interval.

(3) Measuring in the data mode: %T, Abs, E(S), E(R) are available.

2.4.4 Time Scan

(1) Photometric values can be printed out at a specified time interval.

(2) Results of rate calculation can be displayed and printed out.

(3) Measuring time length can be specified 60 to 99999 seconds.

2.4.5 Secondary Processing of Data

The instrument can store measurements in the memory permitting stored data to be processed in various manners.

- Automatic Readout of Data

A cursor can be displayed on the graph currently appearing on the LCD, and the photometric value at the cursor position can be read out.

- Peak Detection

Peaks and valleys on the spectrum currently on screen can be automatically detected.

- Scale Changing

Zoom-in/out of the measured spectrum view is available by changing the scale of the vertical or horizontal axis.

2.4 Measuring Functions

- Smoothing
Smoothing the measured spectrum is available. This is useful to eliminate noise on the spectrum.
- Differentiation
Spectrum can be differentiated. Derivative order, smoothing order, number of data can be specified as desired.
- Arithmetic Operation between Spectra
Applying the four arithmetic operations between spectra is available; or multiplying operation using a coefficient over the displayed spectrum is available.
- File Conversion
Converting files into ASCII text file and JCAMP-DX file is available
- Font for Displaying and Printing
Font, style, and size of characters for displaying and printing are changeable as desired.

2.4.6 Baseline Correction

The baseline is stored in the backup RAM in the spectrophotometer main unit. Data is retained even if the power is turned OFF.

- System baseline
- User baseline

2.4.7 Auto Calibration and Self-Diagnosis Functions

Model U-2910 is equipped with the following auto calibration and self-diagnosis functions.

- (1) Memory (ROM/RAM) check
- (2) Wavelength drive system check
- (3) W1 lamp lighting status check
- (4) D₂ lamp lighting status check
- (5) 656.1 nm wavelength check
- (6) Auto wavelength calibration; auto calibration taking emission lines of D₂ lamp as reference wavelength
- (7) Baseline correction

2.5 SPECIFICATIONS

Table 2-1 Specifications of Model U-2910

Optical system	Seya-Namioka mount, double beam
Wavelength range	190 to 1100 nm
Spectral bandwidth	1.5 nm
Stray light	Within 0.05% (220 nm NaI, 340 nm NaNO ₂)
Wavelength accuracy	±0.3 nm (656.1 nm, 486.0 nm)
Wavelength setting repeatability	±0.1 nm
Photometric range	Abs : -3.000 to 3.000 %T : 0 to 300%T Conc : 0.000 to 9999
Photometric accuracy (with NIST SRM 930 or equivalent filter) *1)	±0.002 Abs (0 to 0.5 Abs) ±0.004 Abs (0.5 to 1.0 Abs) ±0.008 Abs (1.0 to 2.0 Abs) ±0.3%T
Photometric repeatability (with NIST SRM 930 or equivalent filter)	±0.001 Abs (0 to 0.5 Abs) ±0.002 Abs (0.5 to 1.0 Abs) ±0.004 Abs (1.0 to 2.0 Abs) ±0.1%T
Wavelength scan speed	10, 100, 200, 400, 800, 1200, 2400, 3600 nm/min (These speeds are not applicable during filter or light source replacement.)
Baseline stability	0.0003 Abs/hr (500 nm 2 hours after power-on)
Baseline flatness	±0.0006 Abs (200 to 950 nm)
Noise level	±0.00015 Abs (500 nm)
Response	Fast, Medium, Slow
Light sources	WI and D ₂ lamps
Light source switching	Auto changeover linked with wavelength Changeover wavelength: Selectable in the range of 325 to 370 nm as desired.
Detector	Silicon photodiode
Display	Color LCD with Backlight (10.4 inch)
Serial I/F	RS-232C (Exclusive for UV Solutions program)
Dimensions	500 mm (W) × 605 mm (L) × 283 mm (H) (PC and printer exclusive)
Weight	Approx. 29 kg
Power requirement	100, 115, 220, 230 or 240 V, 50/60 Hz
Power consumption	300 VA

*1) Take the uncertainty of the filter into consideration when checking.

3. CALIBRATION OF INSTRUMENT

3.1 INTRODUCTION

This chapter provides an explanatory description on the calibration of the instrument.

The 0%T measurement needs a vertical axis calibration. The wavelength calibration requires a horizontal axis calibration.

The 0%T measurement is essential when:

- A measurement on a sample having high absorbance (low transmittance) is required with high accuracy.
- An error message “Calibrate!” is indicated on the screen as shown in Fig. 3-1.

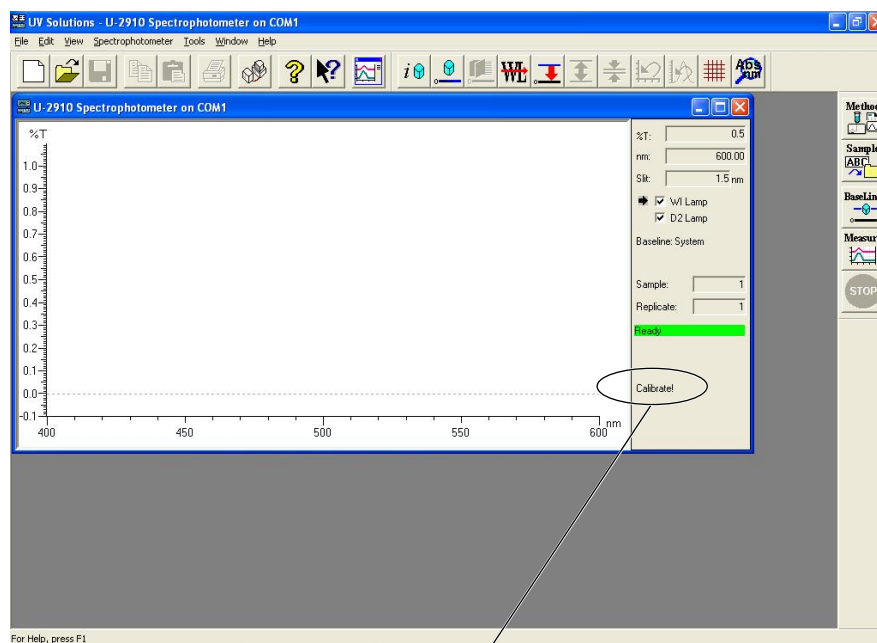

Error message

Fig. 3-1

NOTICE: Use this function only after the spectrophotometer is fully stabilized (at least about 2 hours after turning ON the power switch). The calibration of the instrument should be conducted in the order: 0%T measuring, wavelength calibration, and then baseline measuring (system).

NOTE: Do not open the sample compartment cover or leave the sample in the sample compartment while the wavelength calibration is on going.

3.2 0%T Measurement

3.2 0%T MEASUREMENT

This function corrects the 0%T.

Procedure for the zero-measuring on the sample side is as follows:

- (1) Close the sample compartment lid tightly.
- (2) Click at the instrument calibration command then 0%T in the spectrophotometer menu on the measurement screen.
- (3) Then, the 0%T measuring will start.

3.3 WAVELENGTH CALIBRATION

The wavelength calibration should be conducted using the emission line of the lamp D₂ (656.1 nm), the light source.

Confirm that the sample compartment is completely vacant; then, close the lid thereof tightly.

Click at the wavelength calibration command on the spectrophotometer menu.

The wavelength calibration starts automatically.

NOTE: In this instrument, wavelength is calibrated automatically on start-up. Wavelength may change due to thermal expansion over time of components of the spectroscope, depending on the indoor environment. For more precise measurement, wavelength calibration is recommended after 30 minutes to 1 hour of power-on.

3.4 SYSTEM BASELINE MEASUREMENT

Memorizing the system baseline is available. Follow the below listed procedure to measure.

- (1) Confirm that both the sample side and reference side of the cell holder are completely vacant. Then, click at the baseline setup command in the spectrophotometer menu on the measurement screen; a dialogue box as shown in Fig. 3-2 appears on the screen.

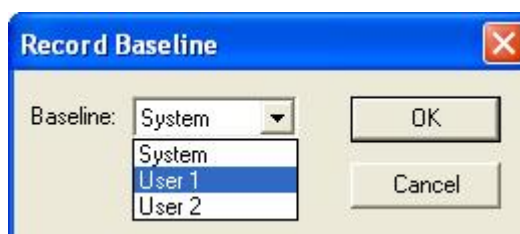

Fig. 3-2 Baseline Setup

(2) Choose "System" and click at [OK] button.

Parameter	Set at:
Data mode	Abs
Starting wavelength (nm)	1100
Ending wavelength (nm)	190
Scan speed (nm/min)	200
Response	Standard
WI Lamp	On
D ₂ Lamp	On

4. MAINTENANCE

4.1 MAINTENANCE AND CHECKUP

4.1.1 Purpose of Maintenance

This spectrophotometer has been constructed precisely with extreme care to provide superlative accuracy in analytical operation. Only proper maintenance ensures this instrument a long-lasting high accuracy.

4.1.2 Cleaning Sample Compartment

If a sample spills inside the sample compartment, immediately remove and clean the sample compartment base as shown in Fig. 4-1.



Fig. 4-1 Removal of Sample Compartment Base

- (1) Fully open the lid of the sample compartment.
- (2) Remove the setscrew on the sample compartment base. Then, take out the sample compartment base.



4.1 Maintenance and Checkup



Fig. 4-2

- (3) Clean the sample compartment base thus removed, and the inside of the sample compartment; otherwise, the optical performance of the instrument may be degraded.
- (4) After cleaning, replace the sample compartment base along the guide pins pushing the base to leave no gaps.

4.1.3 Cleaning Spectrophotometer Cover

Do not put any item such as a measuring sample on the spectrophotometer.

If a sample spills on the instrument, clean the spill using a soft cloth moistened with water or non-stimulating detergent as immediately as possible. After cleaning, let it dry up.

Take particular care not to spill a sample over the keypad.

4.1.4 Cleaning and Storage of Cell

After measurement, wash each cell with distilled water adequately. Swish water off the inside of the cell, and then wipe the cell with a soft cloth or absorbent cotton thoroughly.

For storing the cell, use a desiccator. Alternatively, immerse the cell in distilled water pool using a beaker, then lid the beaker; and store it in a clean place.

If the transmission face of the cell has contamination, clean the face using a soft cloth moistened with a 1:1 mixture of alcohol and ether.

4.1.5 Lubrication

This spectrophotometer has moving parts inside, which have been lubricated at the factory before shipment. If an abnormality is suspected in the internal mechanisms of the instrument, notify your local service office authorized by Hitachi High-Technologies Corporation.

4.1.6 Cleaning Transmission Window Plate of Sample Compartment

If the transmission window plate of the sample compartment is contaminated, remove the plate in the following manner to clean.

- (1) Wash your hands thoroughly.
- (2) Detach the black window frame with tweezers or the like.
- (3) Remove the window plate.
- (4) Clean the window plate using a soft cloth moistened with a 1:1 mixture of alcohol and ether.

<p>NOTICE: In replacing the cleaned transmission window plate, take care not to leave your fingerprints thereon.</p>

4.2 Performance Check

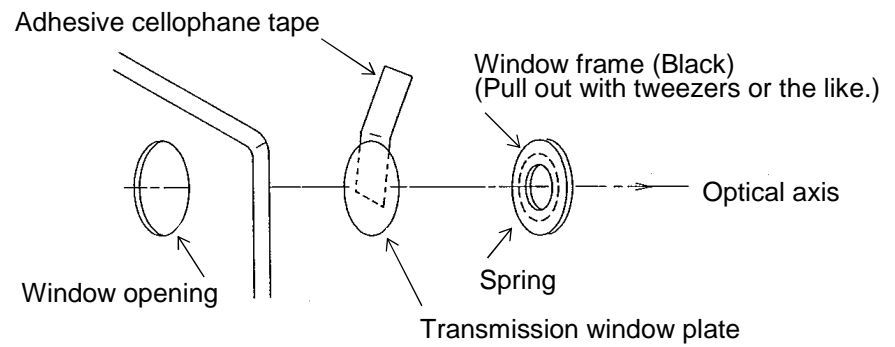

Fig. 4-3 How to Disassemble Transmission Window Plate of Sample Compartment

4.2 PERFORMANCE CHECK

Conduct following performance check after the instrument fully warms.

After turning power on, leave the spectrophotometer for at least 30 minutes until it warms up. Note however that a baseline stability check should be made at least two hours after the power being turned on. The following describes the procedures for respective performance check items.

4.2.1 Wavelength Accuracy

[Summary]

To conduct: measuring emission lines from the D₂ lamp (656.1 nm, 486.0 nm), determining a wavelength having a maximum intensity, and checking the deviation between the indicated wavelength and the specified wavelength.

[Procedure]

⟨General tab⟩

- Measurement mode Wavelength scan
- Apply sample table OFF

⟨Instruemnt tab⟩

- Data mode E(R)
- Start wavelength (nm) 660/490
- End wavelength (nm) 650/480
- Scan speed (nm/min) 100
- Response Fast
- Baseline correction System (*1)
- Initial waiting time (s) 0
- AutoZero before measuring OFF
- Light source switching Use D₂ lamp only
- Switching wavelength (nm) 340.0 (*2)
- Number of measuring times 1
- Cell length (mm) 10 (*1)

⟨Monitor tab⟩

- Open data processing window after measurement ON
- Open data processing window after measurement with spectrum superimposed OFF
- Automatic printing on measuring end OFF
- Display spectrum on the screen with superimposed OFF

*1: On-choice setting is available. This setting does not affect measuring.

*2: This item is masked for protection from a setting by an operator. This setting does not affect measuring.

2. Choose [Edit] - [Sample name/Comment]. Enter, as the sample name, "Wavelength accuracy"; then, enter the file name.

3. Click the measuring button (). (Measurement starts)

4. On completion of the measurement, open the data file of which name was entered at the procedure 2.

4.2 Performance Check

5. Choose [Edit] - [Property] - [Display tab]; and select the peak wavelength in the comment. Click OK button. (This brings, on the screen, the peak wavelength at the peak portion in the spectrum.) If needed, press the auto scaling button () to change the scale.
6. Print the spectrum to read the peak wavelength.
7. Measure likewise with the start wavelength / end wavelength changed to 490 nm / 480 nm.
8. Read the peak wavelength.
9. Confirm that the peak wavelength thus read is within the specified range.

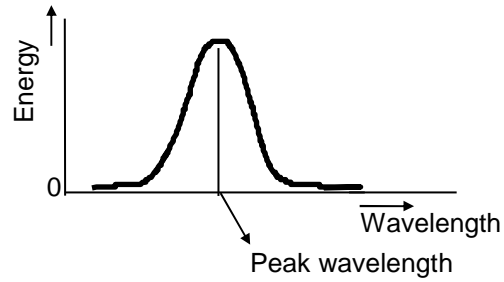

4.2.2 Wavelength Setting Repeatability

[Summary]

To find the dispersion of the wavelength readings over multiple measuring repeated on one emission line from the D₂ lamp.

[Procedure]

1. Choose [Edit] - [Condition setting], then, set conditions as follows:

⟨General tab⟩

- Measurement mode Wavelength scan
- Apply sample table OFF

⟨Instruemnt tab⟩

- Data mode E(R)
- Start wavelength (nm) 660
- End wavelength (nm) 650
- Scan speed (nm/min) 100
- Response Fast
- Baseline correction System (*1)
- Initial waiting time (s) 0
- AutoZero before measuring OFF
- Light source switching Use D₂ lamp only
- Switching wavelength (nm) 340.0 (*2)
- Number of measuring times 1
- Cell length (mm) 10 (*1)

⟨Monitor tab⟩





- Open data processing window after measurement ON
- Open data processing window after measurement with spectrum superimposed OFF
- Automatic printing on measuring end OFF
- Display spectrum on the screen with superimposed OFF

*1: On-choice setting is available. This setting does not affect measuring.

*2: This item is masked for protection from a setting by an operator. This setting does not affect measuring.

2. Choose [Edit] - [Sample name/Comment]. Enter, as the sample name, "Wavelength setting accuracy"; then, enter the file name.
3. Click the measuring button (). (Measurement starts.)
4. On completion of the measurement, open the data file of which name was entered at the procedure 2.

4.2 Performance Check

5. Choose [Edit] - [Property] - [Display tab]; and select the peak wavelength in the comment. Click OK button. (This brings, on the screen, the peak wavelength at the peak portion in the spectrum.) If needed, press the auto scaling button () to change the scale.
6. Print the results to read the wavelength of the emission line of D₂ lamp (656.1 nm).
7. Conduct 2nd measurement changing the wavelength to 1100 nm using the wavelength-shifting button ( or ) , following the same procedures 3 to 6 indicated above.
8. Conduct 3rd measurement changing the wavelength to 190 nm using the wavelength-shifting button ( or ) , following the same procedures 3 to 6 indicated above.
9. Calculate difference between the maximum and minimum in these three measurements. Confirm that the 1/2-value of this difference falls within the specified range.

4.2.3 Bandpass

[Summary]

To determine the spectral width of monochromatic light emitted from the exit slit of the monochromator in terms of the wavelength width (bandpass).

[Procedure]

1. Set the measurement conditions as follows:

〈Measurement menu〉

- Measurement mode Wavelength scan

〈Measuring condition〉

- Data mode E(R)
- Start wavelength (nm) 660
- End wavelength (nm) 650
- Upper scale-end 500
- Lower scale-end 0
- Scan speed (nm/min) 100

〈System condition〉

- Response Fast
- Light source switching D₂ lamp only
- Light source switching
 wavelength (nm) 340.0
- D₂ lamp ON
- Wl lamp ON

2. After setting up the above conditions, press the **Measurement Screen** key. The measurement screen will then appear on the display.
3. Make sure that no sample is placed in the sample compartment; then, press the **Start** key. (Measurement starts.)
4. On completion of the measurement, press **Print** key. If necessary, print out the spectrum after adjusting the scale.
5. Determine the bandpass at 1/2 of the maximum peak height of the spectrum attained.

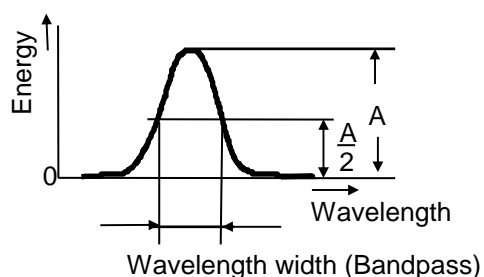

4.2 Performance Check

4.2.4 Noise Level

[Summary]

To determine a variation range of absorbance values measured within a short time under a predetermined measurement conditions with no sample in the sample compartment.

[Procedure]

1. Choose [Edit] - [Condition setting], then, set the conditions as follows:

⟨General tab⟩

- Measurement mode Time scan
- Apply sample table OFF



⟨Instruemnt tab⟩

- Data mode Abs
- Measuring wavelength (nm) 500
- Measuring time (s) 300
- Response Medium
- Baseline correction User 1 (*1)
- Initial waiting time (s) 0
- AutoZero before measuring ON
- Light source switching Automatic
- Switching wavelength (nm) 340.0
- Cell length (mm) 10

⟨Monitor tab⟩

- Horizontal axis maximum 300
- Vertical axis minimum 0
- Open data processing window after measurement ON
- Open data processing window after measurement with spectrum superimposed OFF
- Automatic printing on measuring end OFF
- Display spectrum on the screen with superimposed OFF

*1: On-choice setting is available. This setting does not affect measuring.

2. Choose [Edit] - [Sample name/Comment]. Enter, as the sample name, "Noise level"; then, enter the file name.
3. Click the measuring button (). (Measurement starts)
4. On completion of measurement, print the spectrum. If needed, click the auto-scale button () before printing to print with the scale changed. Calculate difference between the maximum and minimum (peak-to-peak) of the measured photometrical values; then, divide the calculation by two (multiply by 1/2).

[Example] Peak-to-peak value: 0.0003 Abs
Noise level: ± 0.0015 Abs

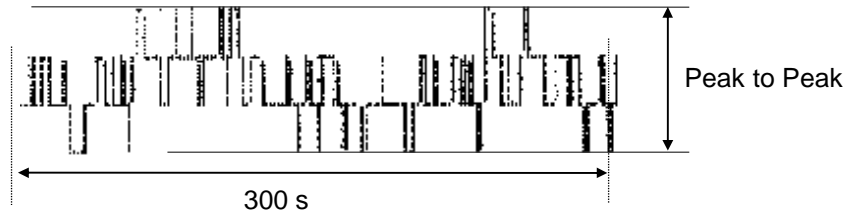

4.2 Performance Check

4.2.5 Baseline Stability

[Summary]

To determine a variation range of absorbance values measured in the vicinity of absorbance zero area under a predetermined fixed measurement conditions for a specified time length with no sample in the sample compartment.

The variation range is determined based on the difference between maximum and minimum absorbance values excluding peaks due to single-shot noises.

[Procedure]

1. Before proceeding to this measurement, wait for at least two hours after power-on.
2. Choose [Edit] - [Condition setting], then, set conditions as follows:

⟨General tab⟩

- Measurement mode Time scan
- Apply sample table OFF

⟨Instrument tab⟩

- Data mode Abs
- Measuring wavelength (nm) 500
- Measuring time (s) 3600
- Response Medium
- Baseline correction User 1 (*1)
- Initial waiting time (s) 0
- AutoZero before measuring ON
- Light source switching Automatic
- Switching wavelength (nm) 340.0
- Cell length (mm) 10

⟨Monitor tab⟩

- Horizontal axis maximum 3600
- Vertical axis minimum 0
- Open data processing window after measurement ON
- Open data processing window after measurement with spectrum superimposed OFF
- Automatic printing on measuring end OFF
- Display spectrum on the screen with superimposed OFF

*1: On-choice setting is available. This setting does not affect measuring.

2. Choose [Edit] - [Sample name/Comment]. Enter, as the sample name, "Baseline stability"; then, enter the file name.
3. Click the measuring button (). (Measurement starts)

4. On completion of measurement, print the spectrum. If needed, click the auto-scale button () before printing to print with the scale changed. Draw a line as shown below passing the center of noises, then, calculate difference between the maximum and minimum on the line.

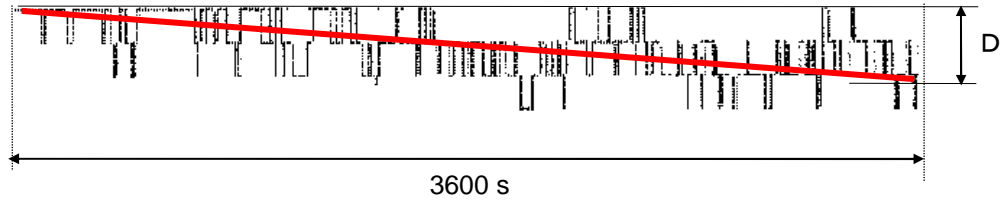

4.2 Performance Check

4.2.6 Baseline Flatness

[Summary]

To determine a systematic variation range* of absorbance values measured in a specified wavelength region with no sample in the sample compartment.

- * The systematic variation means a variation having certain reproducibility, not including noises or other non-reproducible fluctuation.

[Procedure]

2. Choose [Edit] - [Condition setting], then, set conditions as follows:

⟨General tab⟩



- Measurement mode Wavelength scan
- Apply sample table OFF

⟨Instruemnt tab⟩

- Data mode Abs
- Start wavelength (nm) 950
- End wavelength (nm) 200
- Scan speed (nm/min) 400
- Response Medium
- Baseline correction User 1
- Initial waiting time (s) 0
- AutoZero before measuring OFF
- Light source switching Automatic
- Switching wavelength (nm) 340.0
- Number of measuring times 1
- Cell length (mm) 10

⟨Monitor tab⟩

- Open data processing window after measurement ON
- Open data processing window after measurement with spectrum superimposed OFF
- Automatic printing on measuring end OFF
- Display spectrum on the screen with superimposed OFF

2. Choose [Edit] - [Sample name/Comment]. Enter, as the sample name, "Baseline flatness"; then, enter the file name.
3. Choose [Spectrophotometer] - [Baseline measuring], and select "User 1". Click  button. (User baseline measurement starts.)
4. On completion of the baseline measurement, click the measuring button (). (Measurement starts.)

- On completion of measurement, print the spectrum. If needed, click the auto-scale button () before printing to print with the scale changed. Draw segmental lines as shown below connecting centers of noises, then, calculate difference between the maximum and minimum on the line segments. Calculate the breadth from the mid point of the difference.

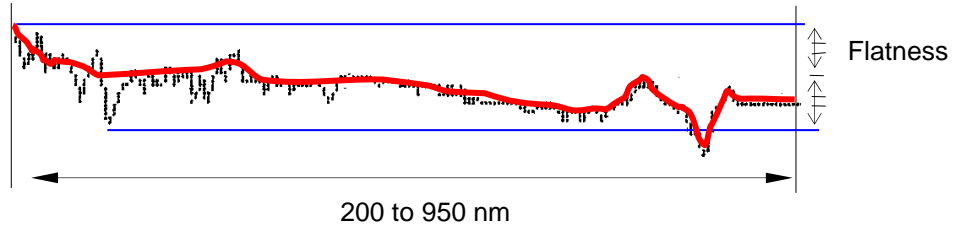

4.3 Troubleshooting

4.3 TROUBLESHOOTING

On occurrence of an abnormality, take a proper countermeasure referring to Table 4-1.

Table 4-1 Troubleshooting Action Table

	Instrument condition	Possible Cause	Action for Remedy
1	Nothing displayed on screen even the power switch is turned on.	Fuse blown out	Replace
2	Message "Calibrate!" appears on screen.	Wavelength calibration data destroyed.	Calibrate instrument. Ask your service section for remedy.
3	Message "D2 lamp1", "W1 lamp!" appears on screen	Lamp broken.	Replace
4	Error message appears on screen	Improper operation	Redo following instruction message on screen.
5	Large fluctuation in displayed data	a. Lamp deterioration b. Lamp contamination with fingerprint c. Dirt or water drip on cell or window plate	a. Replace. b, c. Remove.

If the instrument does not work normally even after the remedy according to the above troubleshooting action table, contact your local sales representative or service office of Hitachi High-Technologies Corporation.



WARNING

This instrument has an electrical part inside that could cause a dangerous electric shock when touched.

Leave inspection of inside of this instrument always to the qualified service personnel.

5. REPLACEMENT OF PARTS

5.1 INTRODUCTION

This spectrophotometer has consumable parts. To minimize an unintentional stop time of the instrument, it is recommended to keep spare parts for replacement at hand as required.

5.2 CONSUMABLE PARTS

Shown below are the consumable parts to be kept as spares. For purchasing these parts, contact your local sales representative or service office of Hitachi High-Tech Science Corporation.

- WI lamp Part No. 885-1200
- D₂ lamp Part No. 2J1-1500
- Main fuse Part No. J821399 (5 A): 115 V
 Part No. J821397 (3.15 A): 220/230/240 V

Guaranteed service life of WI lamp and D₂ lamp

	Guaranteed Life	Guaranty Period	Part No.
WI lamp	1000 h	6 months after purchased by the user	885-1200
D ₂ lamp	350 h	6 months after purchased by the user	2J1-1500

5.3 Replacement of Light Source Lamp

5.3 REPLACEMENT OF LIGHT SOURCE LAMP

5.3.1 Light Source Lamp Replacement Procedure

 WARNING
<p>CAUTIONS in replacement of light source lamp</p> <ul style="list-style-type: none">• If you touch the D₂ lamp power supply (500 V), you may incur fatal or serious injury due to an electric shock. Before proceeding to lamp replacement, make sure that the power switch of the photometer is turned off and the power cord is unplugged.• If you touch hot parts of the D₂ lamp or WI lamp, you may get burnt. After turning the power switch off, always wait for at least ten minutes until the lamp becomes fully cool.• When installing a new lamp, wear clean gloves so that your fingerprints will not be left on the lamp-bulb surface. When handling a new D₂ lamp, use particular care not to leave your fingerprints on its protruded part.• When you check the lighting of the lamp after replacement, do not stare into the lamp with the unprotected eye at a near position. After replacing the light source cover, check the lighting of the lamp from a distant position.

For lamp replacement, take the following procedure.

- (1) Turn the power switch off, and unplug the power cord. Then, wait for about ten minutes until the lamp becomes fully cool. Loosen the setscrew P on the side face of the light source cover, and remove the light source cover.



Fig. 5-1 Light Source Cover



Fig. 5-2

When the cover is removed, the lamps appear as shown in Fig. 5-3.

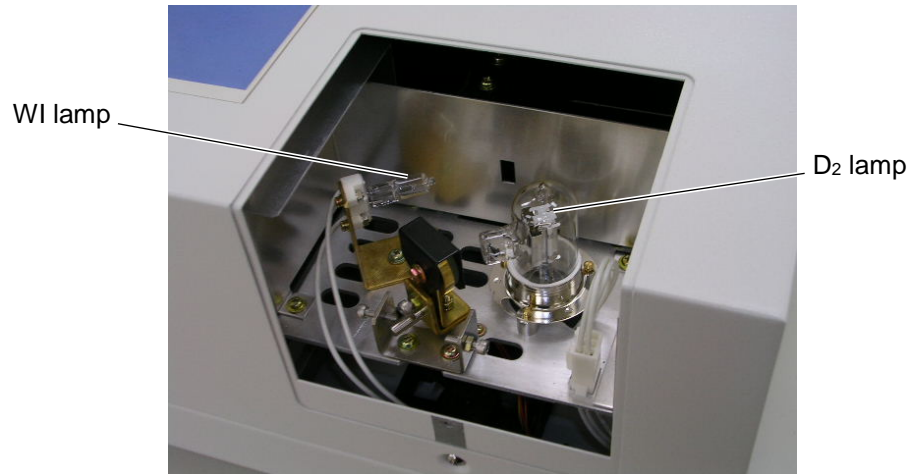

Fig. 5-3

5.3 Replacement of Light Source Lamp

(2) How to Replace the WI Lamp

Loosen the retaining spring, and remove the WI lamp. When installing a new WI lamp, push the lamp deeply enough so that its root will be seated correctly.

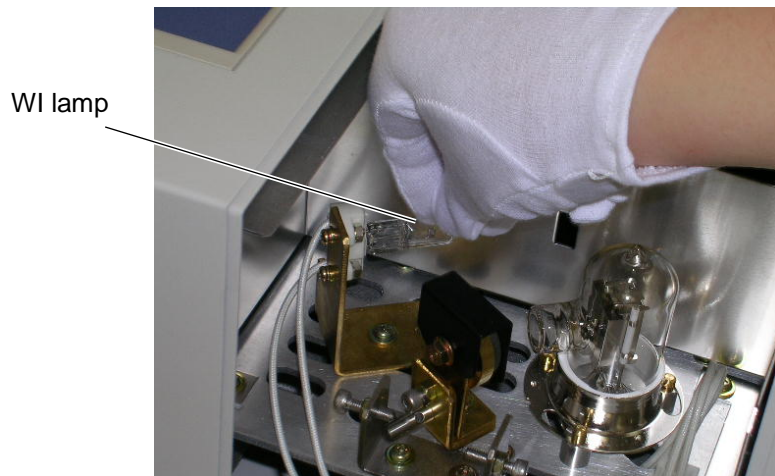

Fig. 5-4 WI Lamp Replacement

NOTICE: Pull WI lamp straightly upward to remove.
An oblique-pull may make it hard to pull out.

(3) How to Replace the D₂ Lamp

(a) Detach the connector.



Fig. 5-5

(b) Holding the metallic part of the D₂ lamp, turn it counterclockwise to remove.

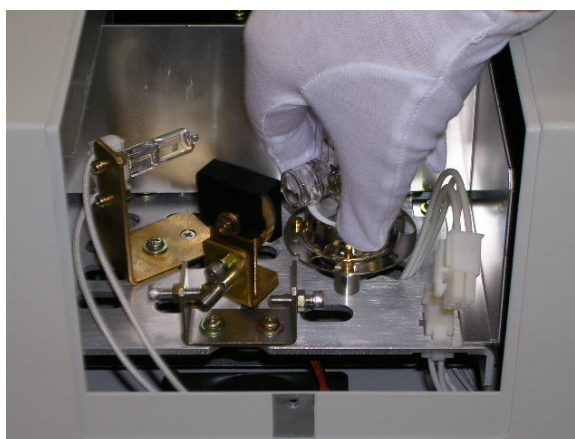

(c) Install a new D₂ lamp in the reverse order of removal.

(4) Replace the light source cover.

5.3.2 Lamp Turn-On Time Resetting

After lamp replacement, reset the lamp turn-on time indication to zero. For details, refer to the separate volume for UV Solutions Instruction Manual.

5.3 Replacement of Light Source Lamp

5.3.3 Lamp Adjustment



WARNING

Adjustment of the light source position is usually not necessary. If however it becomes necessary to adjust the light source position, carry out the adjustment while observing the cautionary instructions given below.

1. Do not touch the W1 lamp and D₂ lamp; they are extremely hot when being turned on.
2. The D₂ lamp emits intense ultraviolet rays. Wear ultraviolet-blocking glasses whenever staring into the lamp is unavoidable.

(1) Adjustment of W1 Lamp Position

- ① Turn off the D₂ lamp.

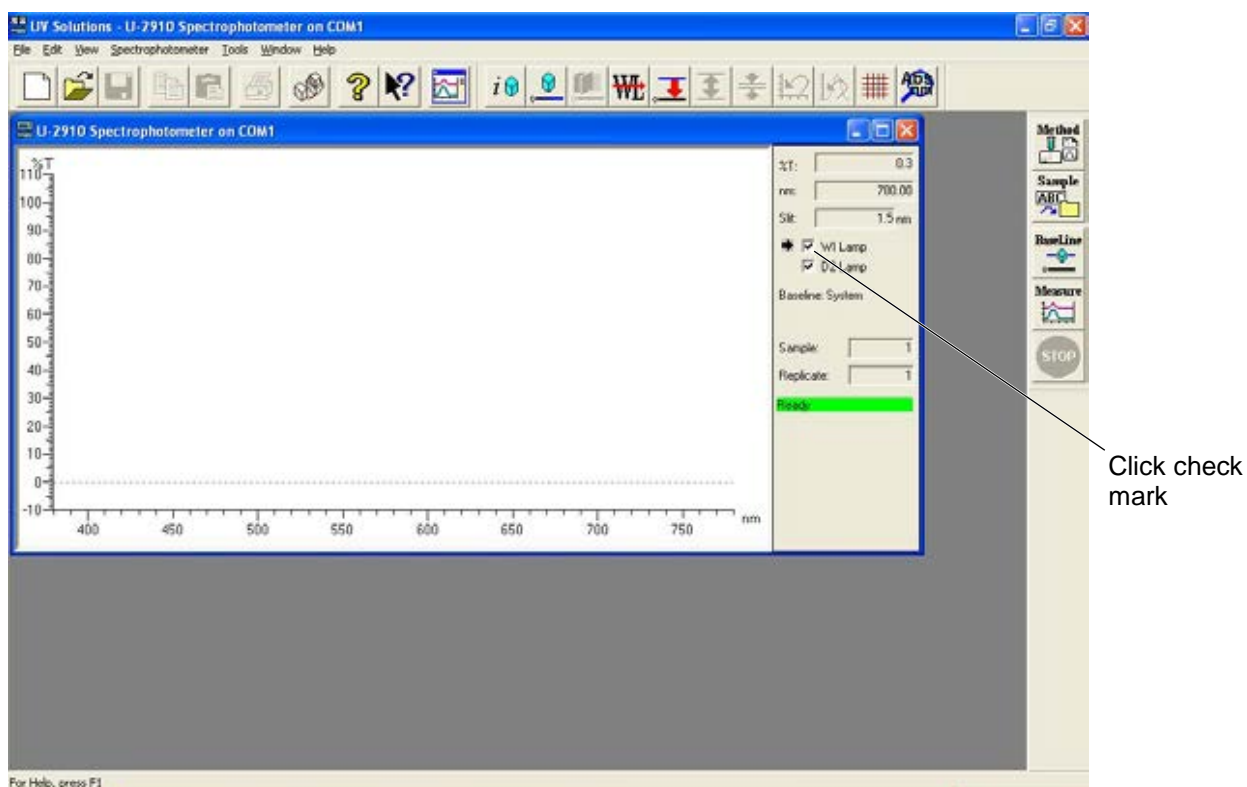



Fig. 5-6

- ② Press the wavelength shift key () to shift to 400 nm. Then, the light source mirror turns to face WI lamp causing the incident light from the WI lamp to ray the slit. Open the light source cover, and check that the image of the lamp forms as shown in Fig. 5-7.

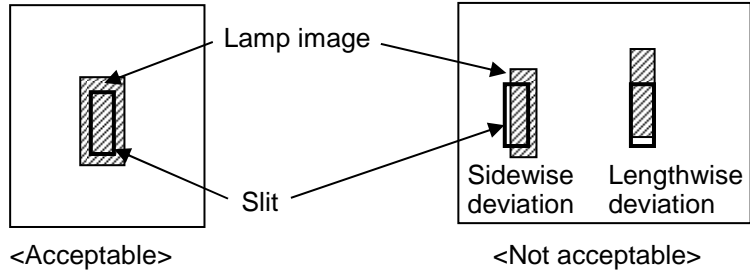

Fig. 5-7

If the lamp image deviates sidewise, adjust the nut A and screw A in the light source compartment.
 If the lamp image deviates lengthwise, check the lamp mounting conditions for being in position.
 Make sure that the lamp is not inclined. If the lamp image deviates still, contact your local service office of Hitachi High-Tech Science Corporation.

The slit is located behind this part. Check lamp image formed on this part.

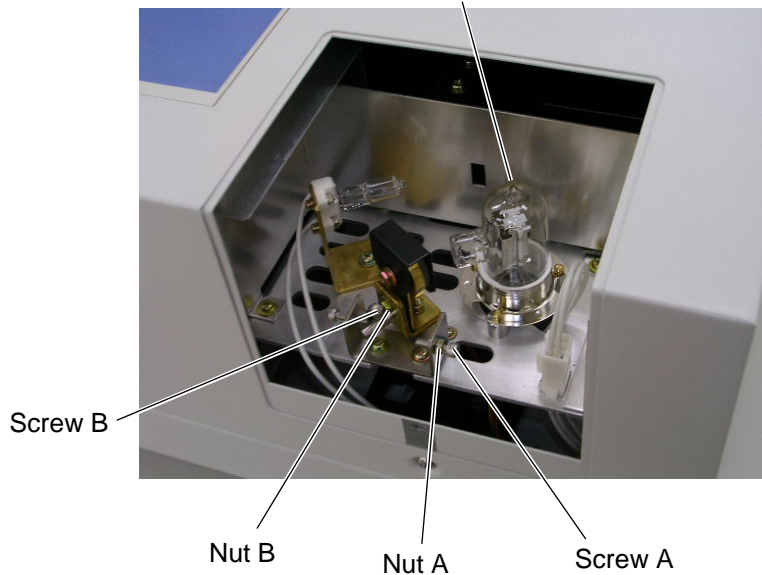

Fig. 5-8

At the end of the adjustment, be sure to secure the nut A tightly.

5.3 Replacement of Light Source Lamp

- ③ Turn on the D₂ lamp.

Click the D₂ lamp check box on the screen as shown in Fig. 5-6, then, a check mark appears causing the D₂ lamp to be turned on.

(2) Adjustment of D₂ Lamp Position

- ① Turn off the WI lamp.

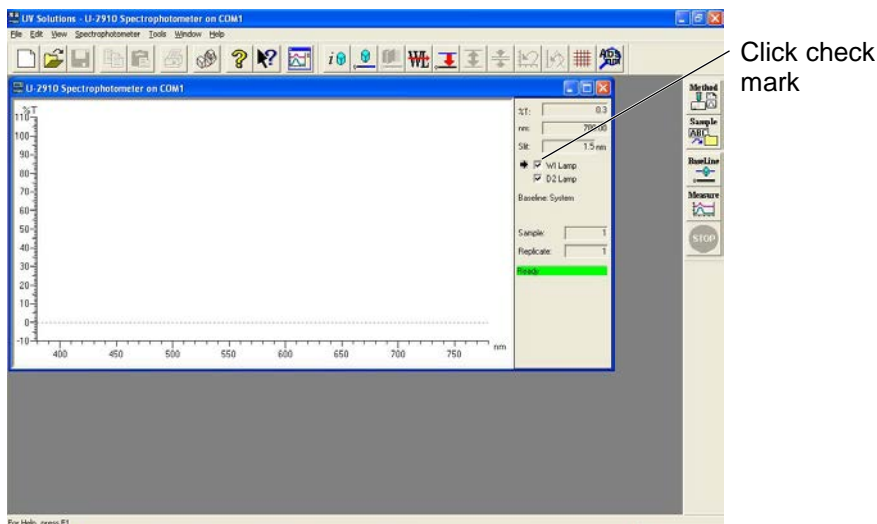



Fig. 5-9

Click the check mark on WI lamp on the screen as shown in Fig. 5-9, then, check mark disappears causing WI lamp to be turned off.

- ② Press the wavelength shift key () to shift to 300 nm. Then, the light source mirror turns to face with D₂ lamp causing the slit to be rayed by an incident light from the D₂ lamp. Open the light source cover, and check that the image of the lamp forms as shown in Fig. 5-9.

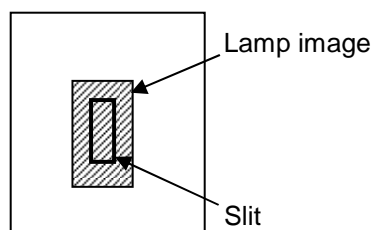

Fig. 5-10

If the lamp image deviates sideways, adjust the nut B and screw B.

At the end of the adjustment, be sure to secure the nut B tightly.

- ③ Turn on the WI lamp.
Click the WI lamp check box on the screen as shown in Fig. 5-9, then, a check mark appears causing the WI lamp to be turned on.

5.4 STORAGE

5.4.1 After Measurement

- (1) Turn the power switch off, and unplug the power cord from power outlet.
- (2) Place the cover sheet (option) over the instrument.

NOTICE: If an organic solvent sample or a toxic gas sample has been set in the sample compartment, be sure to remove it after completion of measurement. Never leave these kinds of samples in the instrument after measurement.

5.4.2 When Instrument will not be used for Long Time

- (1) Store the instrument preventing exposure to a high temperature (60 °C or higher), a low temperature (-20 °C or lower), a high humidity (80% or higher), and intense vibration.
- (2) Place the cover sheet over the instrument without fail.
- (3) Take care so that a detrimental gas such as a strong acid/alkali vapor will not intrude into the instrument.
- (4) Before moving the instrument to a storage place, be sure to fix the light source mirror. If the instrument is moved with the light source mirror not fixed, an instrument failure may be caused by impact or vibration. For fixing the light source mirror, use the sponge packing described in Section 1.1.
- (5) Avoid storing the instrument in such a place as produces magnetism.
- (6) Avoid a dusty environment for storage of the instrument.
- (7) Avoid storing the instrument in a place exposed to direct sunlight.

APPENDIX 1. ABSORPTION SPECTROPHOTOMETRY

The spectrophotometer is applicable to absorption analyses of liquid, solid, and gaseous samples in ultraviolet and visible spectral regions.

Assuming that a monochromatic beam with intensity “ I_0 ” travels through a liquid having concentration “ c ” across an optical path length “ ℓ ” with a residual intensity of “ I_t ” as shown in Fig. 1, the relationship between “ I_0 ” and “ I_t ” is expressed with Equation (1) called Bouguer-Beer’s Law.

$$I_t / I_0 = 10^{-\epsilon \cdot c \cdot \ell} = t \dots\dots\dots (1)$$

where, “ ϵ ” is a constant called the absorption coefficient, a specific character of the sample substance, and “ t ” represents the transmittance of the sample.

As a common practice in spectrophotometry, the value of transmittance is expressed as:

$$t \times 100 = T \text{ (Percent transmittance, or \% -transmittance, or \%T)}$$

Using the common logarithm of the reciprocal number of the transmittance t , the relationship can be expressed also in:

$$\log (1/t) = \epsilon \cdot c \cdot \ell = E \dots\dots\dots (2)$$

where, “ E ” represents the absorbance (Abs) of the sample. Since the absorbance “ E ” is directly proportional to the concentration “ c ”, it is indispensable for quantitative determination to measure this property, not measuring the transmittance. This instrument provides two measuring modes: transmittance and absorbance.

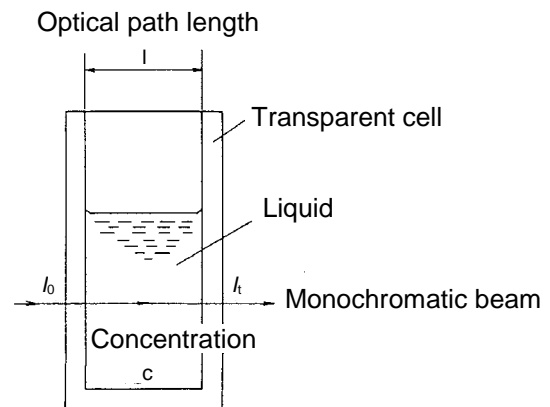

Fig. A1-1 Bouguer-Beer’s Law

APPENDIX 2. FOR PROPER USE OF SPECTROPHOTOMETER

2.1 SOLVENT SELECTION

For selecting a solvent in the sample preparation, make sure that the solvent satisfies following requirements:

- Little absorption within the measurement wavelength range.
- Not interactive with the solute.
- Low volatility.

Table 2-1 shows the applicable wavelength ranges of organic solvents widely used in common applications. (For details, refer to "Lectures on Experimental Chemistry" Vol. 15, Part I, edited by the Chemical Society of Japan.)

Table A2-1 Applicable Wavelength Ranges (Indicated by the solid lines)

Solvent	Wavelength		
	200 nm	300 nm	400 nm or more
Cyclohexane	200 nm		
Ethyl alcohol	220 nm		
Methyl alcohol	220 nm		
Ethyl ether	220 nm		
Dioxane	220 nm		
Hexane	220 nm		
Chloroform	250 nm		
Isopropyl alcohol	250 nm		
Acetic acid	250 nm		
Ethyl acetate	270 nm		
Carbon tetrachloride	275 nm		
Benzene	280 nm		
Methyl ethyl ketone		335 nm	
Acetone		340 nm	
Carbon disulfide			380 nm

2.2 SPECIAL SAMPLES

Note that Equations (1) and (2) indicated in APPENDIX 1 are not valid in analyzing the following samples:

- Fluorescing samples
- Samples having high turbidity

In measurement of a solid sample such as glass plate, a loss (r) in optical energy occurs due to reflection on the sample surface. In this case, the following equation is valid.

$$I_t / I_0 = 10^{-\epsilon \cdot c \cdot \ell} - r \dots\dots\dots (3)$$

where, “ r ” varies depending on the sample substance.

INDEX

A

ASCII text file	2-8
Automatic calibration, self-diagnosis	2-8
Automatic readout of data	2-7
Atmosphere, Gas	1-3

B

Bandpass.....	4-9
Baseline correction	2-8

C

Cleaning spectrophotometer cover	4-2
Creation of calibration curve	2-6
Cable connection	1-7
Consumable parts.....	5-1
Cleaning sample compartment.....	4-1
Cleaning transmission window plate of sample compartment	4-3
Control system.....	2-5
Cleaning and storage of cell.....	4-3

D

Data mode	2-7, 3-3
Differentiation.....	2-8

E

Error message	3-1
Earthquake measure.....	1-5

F

Frequency.....	1-2
File conversion.....	2-8
Floor area	1-2
Fuse	1-6, 4-16

G

General tab.....	4-5, 4-7, 4-9, 4-10, 4-12, 4-14
Grounding line	1-2

I

Installation	1-1
Instrument tab.....	4-5, 4-7, 4-10, 4-12, 4-14

J

JCAMP-DX File.....	2-8
--------------------	-----

L	
Light sources	2-9
Light source switching.....	2-9
M	
0%T measurement.....	3-2
Maintenance and checkup	4-1
Monitor tab.....	4-5, 4-7, 4-10, 4-12, 4-14
N	
Noise level	2-9, 4-10
O	
Optical system	2-4, 2-9
Operating temperature range.....	1-2
Operating humidity range.....	1-2
P	
Performance check	4-4
Power-on	1-9
Photometric repeatability.....	2-9
Photometric accuracy	2-9
Photometric range.....	2-9
Power supply voltage.....	1-2
Power source capacity.....	1-2
Power switch.....	4-16
Peak detection	2-7
Q	
Quantitative calculation.....	2-6
R	
RS-232C.....	2-2, 2-9
Replacement of parts.....	5-1
Replacement of light source lamp	5-2
RUN Lamp.....	2-3
Rate calculation	2-7
Response	2-9, 3-3
S	
System baseline	2-8, 3-2
Specifications.....	2-9
Signal processing.....	2-5
Scan speed.....	2-7, 3-3
Scale changing	2-7
Standard.....	2-6
Spectral bandwidth	2-9
Smoothing	2-8

Seya-Namioka mount	2-4, 2-9
Secondary processing of data.....	2-7
Statistical calculation.....	2-7
Storage	5-9
Storage temperature	1-2
Stray light.....	2-9
Spare parts	5-1

T

Troubleshooting action table	4-16
Time scan	2-7

U

User baseline.....	2-8
--------------------	-----

W

Work table strength.....	1-2
Wavelength drive system	2-8
Wavelength calibration.....	3-2
Wavelength scan	2-6, 2-7
Wavelength accuracy.....	2-9, 4-5
Wavelength setting repeatability	2-9, 4-7

Z

Zero-measuring on the sample side.....	3-2
--	-----